

AUTOMATE™

QUICK START GUIDE Automate™ Avant INTERGRATION SUPPORT

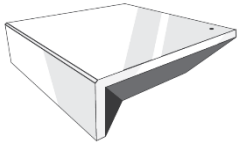

AUTOMATE PULSE HUB 2 OVERVIEW

Take your Automate experience to the next level by integrating Automate motorized shades into Savant's industry-leading of Smart Home control systems. The Automate Pulse 2 is a rich integration supports discrete shade control and features a two-way communication system offering real time shade position and battery level status. The Automate Pulse Hub 2 supports Ethernet Cable (CAT 5) and Wireless Communication 2.4GHz) for home automate integration using the RJ45 port conveniently located on the back of the hub. Each hub can support integration of up to 30 shades

STEP 1:

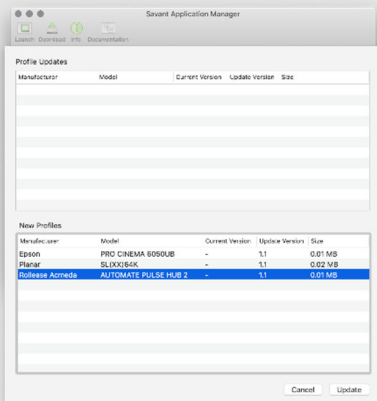

Open the Savant Application Manager and update your profile library. If you do not already have the Rollease Acmeda AUTOMATE PULSE HUB 2 profile in your library, it will appear in the "New Profiles" list.

STEP 2:

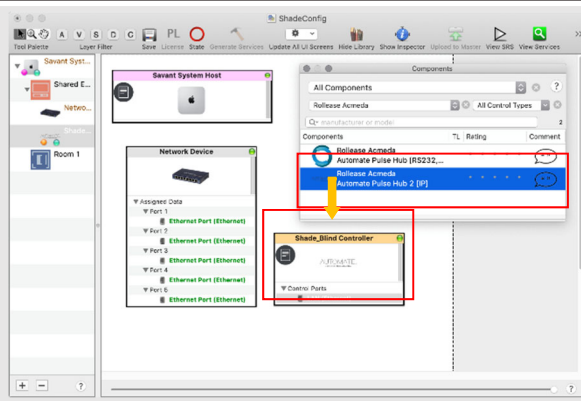

Open your current Blueprint configuration and locate the Rollease Acmeda profile within the Library, then drag the item into your Blueprint canvas.

STEP 3:

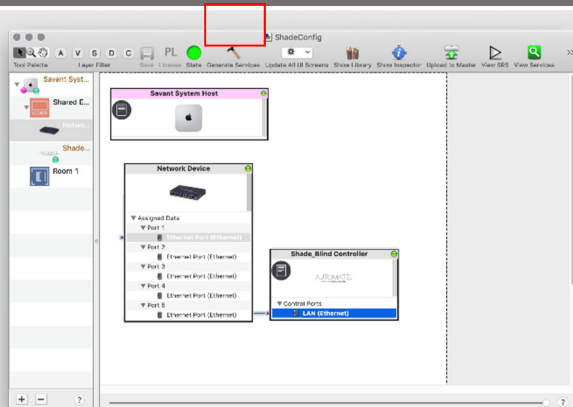

Make a connection between the "LAN (Ethernet)" port on the Shade Controller profile and the "Ethernet Port (Ethernet)" port on a Network Switch profile. Then click the "Generate Services" button.

STEP 4:

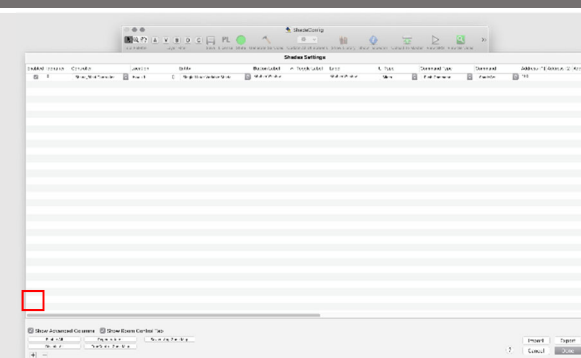

Navigate to Tools > Settings > Shades... in the menu to locate the "Shade Settings" data table. Click the "+" button, in the bottom-left of the screen, to add a new shade. Set values for the following:
Location (EX: Room 1),
Entity (EX: "Shade" for Up-Down-Stop buttons, or "Shade Motor Variable Shade" for a shade slider),
Label (EX: "Kitchen Window"),
Address [1] (EX: 19X). This must be in the form of a 3-character string. The addresses are the same as those displayed on your Automate Pulse 2 app.

STEP 5:

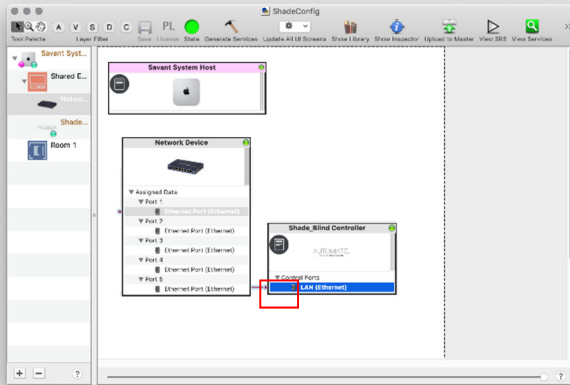

The "Notes" section of the profile provides additional details about setup or use. This section may be updated over time.

STEP 6:

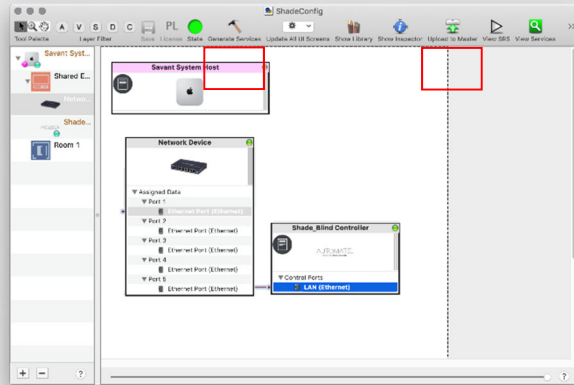

Click the "Generate Services" button again, then "Upload to Master" to push the configuration to the Savant Host.

SAVANT CONTROL SYSTEM CONNECTION:

INTEGRATION TOPOLOGY

SAVANT

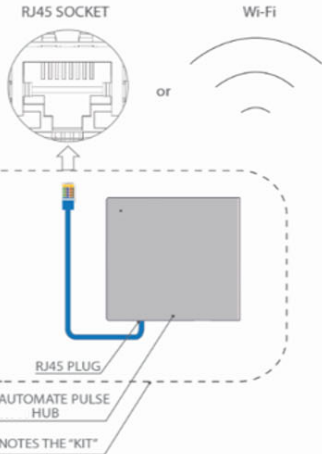

ADDITIONAL INFORMATION:

- The CAT 5 cable should be no longer than 100 meters (328ft).
- Router, switch or access point are required to connect the Hub via LAN connection;
- Wi-fi repeater is required depending on the cover of the Wi-fi Router signal.
- The AUTOMATE PULSE HUB 2 works only with Wi-fi in 2.4Ghz (not 5Ghz)

AUTOMATE PULSE HUB 2

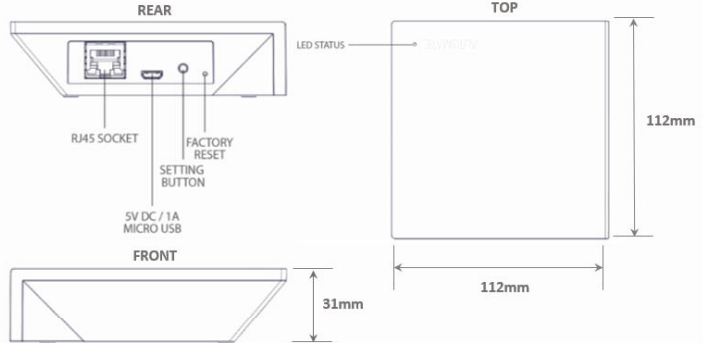

CONNECTIONS

The standard connections of the Automate Pulse Hub 2 is Ethernet or Wi-fi. For a LAN connection, you can use a straight Through wiring accordingly indicated below:

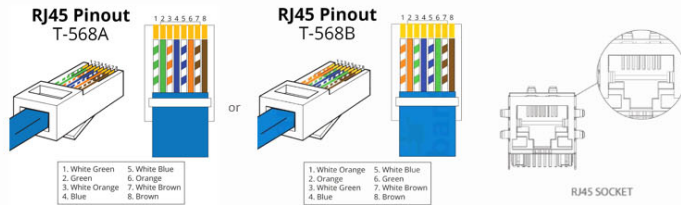

FREQUENTLY ASKED QUESTIONS:

Q. No Automate Pulse Hub 2 detected.

A. Make sure that your Automate Pulse 2 is assigned to the correct network and get an IP Address available and still communicating with the network using the Automate Pulse App 2.

Q. Shade limits are not set properly.

A. Calibrate shade limits with your Rollease Acmeda remote before setting the appropriate open and close time within SAVANT SYSTEM.

Q. Shade is not moving at all.

A. Make sure the selected Pulse Hub 2 is the correct Pulse Hub 2 for the shade to be controlled. Confirm the correct bindings are set in the SAVANT System connections tab between the Pulse Hub 2 and Shade drivers.

Q. I have multiple Pulse Hub's 2, what do I do?

A. Load two Pulse Hub 2 drivers. After selecting "Retrieve Hubs" located in the driver actions tab, you will see different Pulse Hubs - select the desired one.

Q. I don't see any shade bindings in the Pulse Hub 2 driver?

A. Select "Retrieve Shades" located in the driver actions tab.

Q. How do I scan for available Pulse Hub's 2?

A. Once the Pulse Hub 2 is properly connected via the Ethernet cable or Wireless network, navigate to the Pulse Hub 2 Properties page within Composer. Select "Retrieve Hubs" located in the driver actions tab.

Q. We get unexpected responses from the SAVANT System, or "?" symbols

A. Ensure that all connections using the ethernet port or Wi-Fi are working properly. The missed connection has been known to yield unwanted or unexpected results.

SUPPORT RESOURCES:

For further assistance, contact your retailer, visit our website at www.rolleaseacmeda.com.