

**OVERVIEW: SQUARE CASSETTE 110**

The Square Cassette 110 system is a decorative one piece cover providing an elegant finish, compatible with S45 Roller Shade systems, Skyline tubes (1-1/2", 2") and Skyline clutches (SL10, SL15 & SL20).

**Aesthetic Features**

- Elegant Square Finish
- Fabric Wrap Option with Spline Function

**Installation Benefits**

- One piece design
- Additional bracket security
- Flush-fit color coded end-caps
- Compartment for Fabric Brush to reduce light

**Functional Benefits**

- Compatible with zebra shades
- Uses LX brackets (S45 & Skyline Systems)

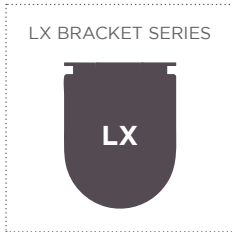
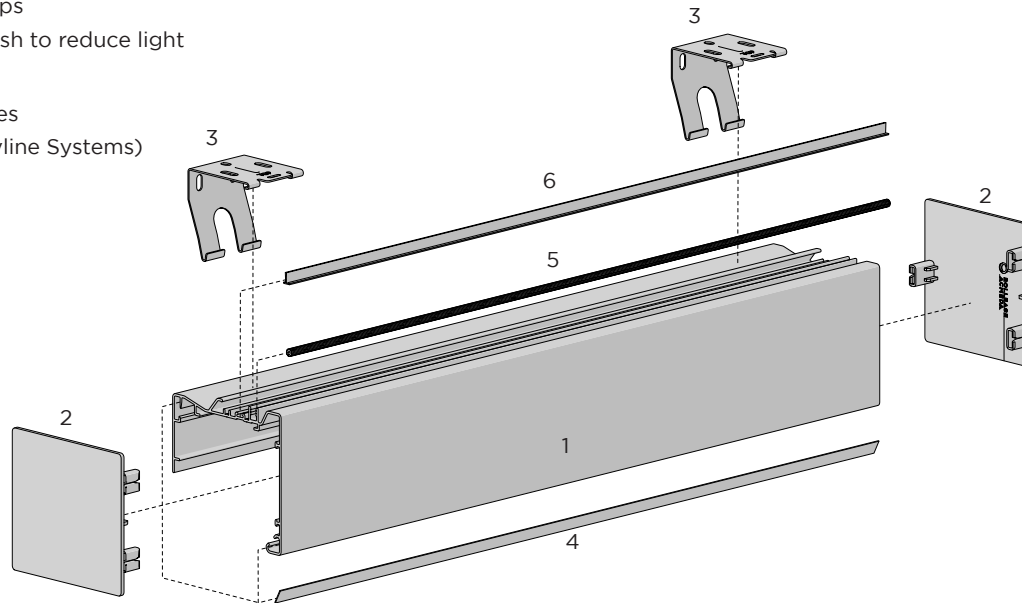

**SYSTEM INDEX**

1	Sq Cassette 110 Headrail 16' SB20-0504-xxx490
2	Sq Cassette 110 End Cap SB20-0503-xxx000
3	Cassette 100 & 110 Mounting Bracket SB20-0202-xxx100
	9mm Flat Spline
	RB92-0902-001075 (double sided tape on one side)
	RB92-0903-001075 (double sided tape on both sides)
5	Round Ribbed Spline SS91-5237-050500 3.7mm SS91-5241-050500 4.1mm SS91-5246-050300 4.6mm
6	Fabric Brush AW91-1501-050000

xxx= colour

**COLOUR RANGE**



**LX BRACKET OPTIONS**

LX Skyline Bracket | 40mm Proj  
SL01-0306-xxx040

Easy-Lock LX Bracket | S45  
RB09-0352-xxx040

Easy-Lock Gear Small LX Brackets  
RB05-9359-069040

Easy-Lock LX Bracket | S45  
RB40-9355-xxx040 RB09

Screw #6 x 3/8" Hex Slotted  
SC6375H25

**SYSTEM OPTIONS**

SKYLINE/S45

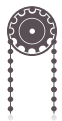

CRANK GEAR



MOTORISED



ESU/ESW



EASY-I INK

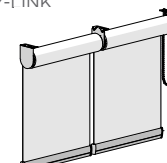

SPECIFICATIONS

DIMENSIONS

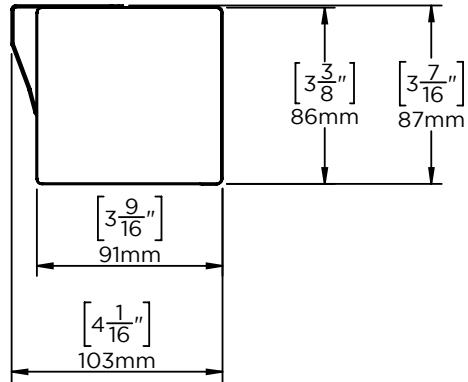

DEDUCTIONS

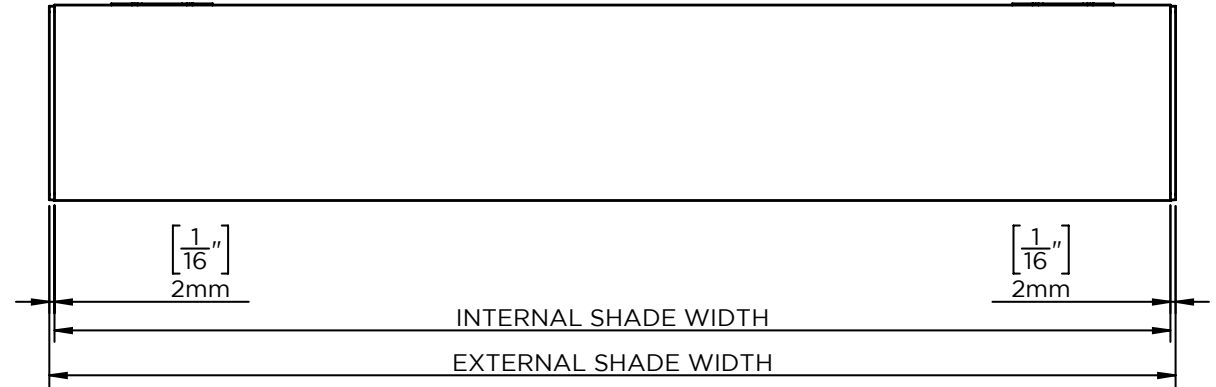

MAX ROLL

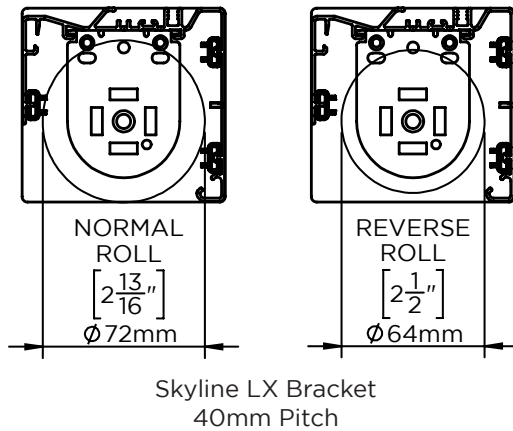

SQUARE CASSETTE 110 WITH FABRIC ATTACHED

