

EASY SPRING WAND

Rollase Acmeda Easy Spring Wand single roller system offers a high quality, aesthetically pleasing and technologically advanced Wand or Shade controlled solution. The shade will open to your preferred top location in a smooth and controlled motion, with one simple touch.

AESTHETICAL FEATURES

- Minimal light gaps
- Color matched bracket covers provide a neat overall finish
- Alternative cassette upgrade
- Clean installation without chain or tensioner

PRODUCTION / ASSEMBLY FEATURES

- Easy Pre-tensioning through control bracket
- Single Top Limit Setting function, simple and intuitive to set the limit
- Color coded LH & RH hardware for quick & easy assembly
- Universal Single Stop Limiter for both orientations

FUNCTIONAL BENEFITS

- Premium child safety with easy to operate wand control
- Alternative weight bar override control
- Auto-rise functionality with manual lowering
- Top limit setting for an easy user experience
- Can be installed onto wall, ceiling & inside fix applications
- Patent protected
- Decelerator for smooth controlled movement
- Compatible with Link System (refer to charts)

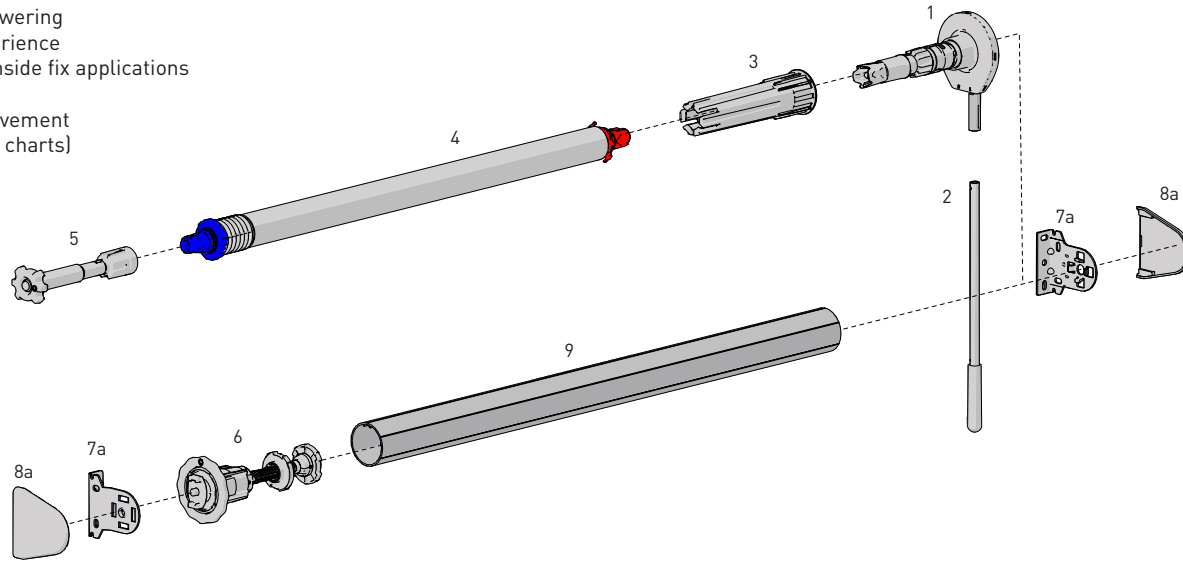

COLOR RANGE



SYSTEM INDEX

1	Wand Control	RB12-3301-069138 LH RB12-3301-069238 RH
2	Wand	RB12-9001-069090
3a	Connector 1.5"	RB12-3810-069038
b	Connector S45	RB12-4510-069045
4a	Booster Uni. 1.5"	RB12-3800-269038 - Short RB12-3801-069038 - Light RB12-3802-338038 - Standard
b	Booster Uni. S45	RB12-4500-269045 - Short RB12-4501-069045 - Light RB12-4502-338045 - Standard RB12-4503-050045 - Heavy Duty
5a	Booster Decelerator 1.5"	RB12-7112-190038 - RH RB12-7111-393038 - LH
b	Booster Decelerator S45	RB12-7112-190045 - RH RB12-7111-393045 - LH
6a	Limiter - Single Stop Universal 1.5"	RB12-6101-069038
b	Limiter - Single Stop Universal S45	RB12-6101-069045
7a	Standard Bracket Set 1.5"	RB12-2501-069138
b	Single Stop Limit LX Bracket Set S45	RB12-2503-069140
8a	Skyline Bracket Cover	SLBCW
b	LX Bracket Cover Caps	RB08-4151-069040
9a	Aluminum Tube 1-1/2" Taped	RTEA-4T05-000580 (AU Only) RTEA4T16 (US Only)
b	T-Spline Aluminium Tube S45	RB93-6443-000LLL - Light RB93-6444-000LLL - Standard RB93-6449-000LLL - Heavy Duty

SYSTEM UPGRADES

Cassette 100/120

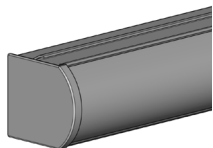

USE 1.5" CASSETTE 100/120 BRACKETS

Link System

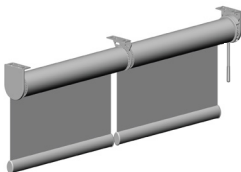

CF90

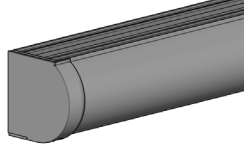

USE VX/LX BRACKETS

Pelmet 95



USE VX/LX BRACKETS

PRODUCT OPTIONS

S45 Roller Shade
(refer catalog)

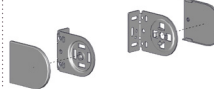

Mounting Rail



USE VX/LX BRACKETS

SPECIFICATIONS

SYSTEM CAPACITY

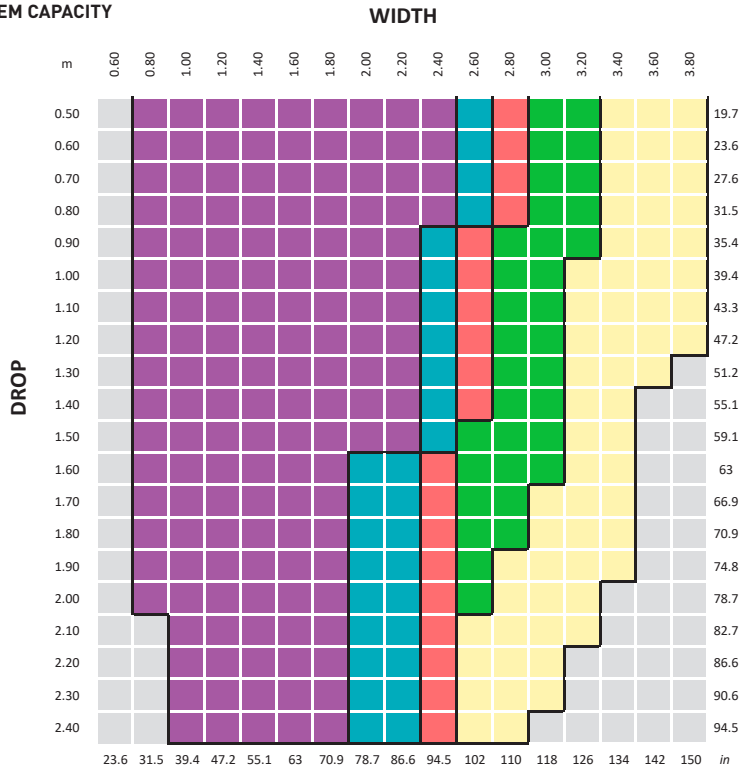

TUBE

1.5"	
S45 LT	
S45 STD	
S45 HD	
LINKED*	
OUTSIDE PRODUCT SPECIFICATION	

PARAMETERS:

FABRIC DENSITY: 0.420gsm
 FABRIC THICKNESS: 0.6mm
 WEIGHT BAR: D30 Bottom Rail
 MIN WIDTH = 750mm [29.5"]
 *SEE PRETENSION CHARTS FOR LINKED CAPACITY

DEDUCTION

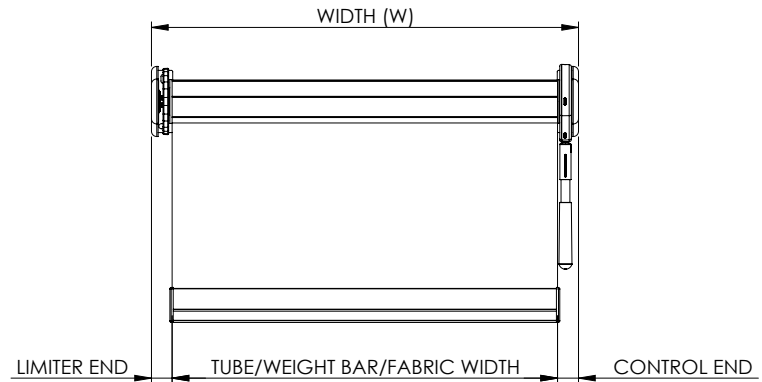

CONTROL TYPE	CONTROL	LIMITER	TOTAL DEDUCTIONS	
			WithOut Covers	With Covers
Skyline (SLB660 Brackets)	18mm [11/16"]	18mm [11/16"]	36mm [1-7/16"]	39mm [1-9/16"]
Skyline (LX Brackets)	16mm [5/8"]	18mm [11/16"]	34mm [1-5/16"]	36mm [1-7/16"]
CF90 Cassette (Skyline LX Brackets)	20mm [13/16"]	22mm [7/8"]		42mm [1-5/8"]
Cassette 100/120	20mm [13/16"]	20mm [13/16"]		40mm [1-9/16"]
Pelmet 95 (Skyline LX Brackets)	19mm [3/4"]	21mm [13/16"]		40mm [1-9/16"]

TUBE SPECS

USA 1-1/2"

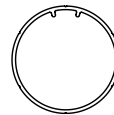

1-1/2" Rollease Tube + M/P Tape

Code: RTEA4T
 OD: 38.6mm [1.5"]

AU 1-1/2"

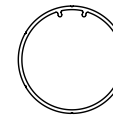

1-1/2" Rollease Tube + M/P Tape

Code: RTEA-4T05-000LLL
 OD: 38.6mm [1.5"]

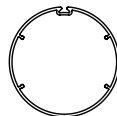

S45 LIGHT T-Spline Tube

Code: RB93-0443-000LLL
 RB93-6443-000LLL [with D/S tape]
 OD: 43mm [1.69"]

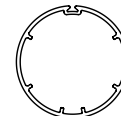

S45 STANDARD T-Spline Tube

Code: RB93-0444-000LLL
 RB93-6444-000LLL [with D/S tape]
 OD: 44mm [1.73"]

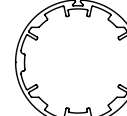

S45 HEAVY DUTY T-Spline Tube

Code: RB93-0449-000LLL
 RB93-6449-000LLL [with D/S tape]
 OD: 49mm [1.92"]

MAX ROLL

1.5"

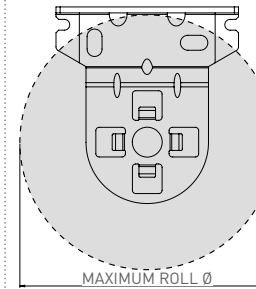

MAXIMUM ROLL Ø

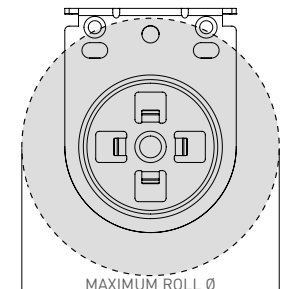

MAXIMUM ROLL Ø

MAXIMUM ROLL SIZE CHART

1.5" Bracket	78mm	3.071"
VX/LX withOut Mounting Rail	78mm	3.071"
VX/LX with Mounting Rail	72mm	2.835"