

SYSTEM UPGRADE | EASY SPRING ULTRA

The Easy Spring Ultra system upgrades offer a streamlined solution with significant improvements across assembly and installation. The introduction of a new pre-tension clip is coupled with a number of product changes all of which are outlined below.

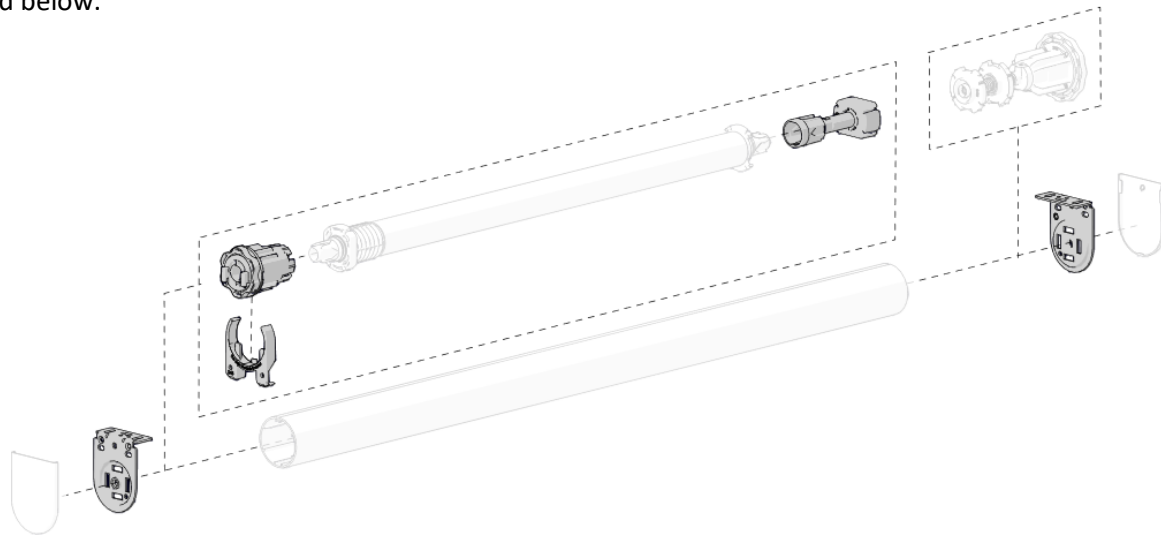

AVAILABLE. October 2023

NEW PRODUCT

DESCRIPTION.	ESU Pre-Tension Retaining Clip 45mm
CODE.	RB12-4512-503045
PRICE.	
IMAGE.	
PURPOSE.	<ul style="list-style-type: none"> Designed to securely retain spring pre-tensions during transportation and installation. Brightly coloured, prompting removal once installed to allow shade operation. Reusable for multiple shades.

PRODUCT CHANGES

	DISCONTINUED PRODUCT	REPLACEMENT PRODUCT
DESCRIPTION.	LX Skyline & RB12 Control bracket set 40mm	LX SKYLINE BRACKET 40mm
CODE.	RB12-2503-069140	SL01-0306-069040
PRICE.		
IMAGE.		
PURPOSE.	<ul style="list-style-type: none"> Skyline Bracket offers secure engagement with spring control head. Easier to locate controls and install. Universal – Used at each end reducing inventory. 	

SYSTEM UPGRADE | EASY SPRING ULTRA

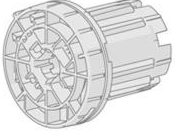
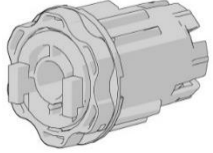
	DISCONTINUED PRODUCT	REPLACEMENT PRODUCT
DESCRIPTION.	Single Chainfree Control S45	Spring Control with Tension Adjust Skyline S45
CODE.	RB12-3200-069045	RB12-4570-069045
PRICE.		
IMAGE.		
PURPOSE.	<ul style="list-style-type: none"> • The Spring Control with Tension Adjust offers the capability to add or remove spring tensions while shade is installed. • Designed with finger grip contours allowing installer to clasp and rotate control head by hand. • No extra tools required. 	

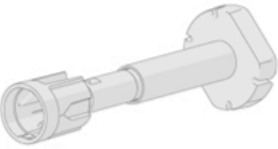
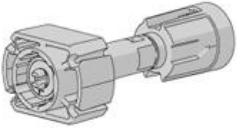
	DISCONTINUED PRODUCT	REPLACEMENT PRODUCT
DESCRIPTION.	Soft Lift Decelerator S45 LH	Decelerator S45 LH
CODE.	RB12-7101-393145	RB12-7111-393045
PRICE.		
IMAGE.		
PURPOSE.	<ul style="list-style-type: none"> • Minimum shade widths have reduced by 38mm with each booster type. • Tail of decelerator is blue as a reminder for LH control only. 	

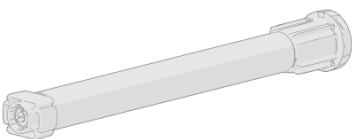
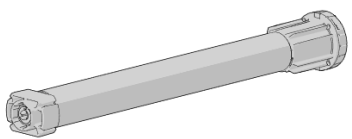
	DISCONTINUED PRODUCT	REPLACEMENT PRODUCT
DESCRIPTION.	Compact Booster S45 LH	Compact Booster S45 LH Skyline
CODE.	RB12-4505-069045	RB12-4515-069045
PRICE.		
IMAGE.		
PURPOSE.	<ul style="list-style-type: none"> • Compact Booster is an all-in-one design with Control, Booster and Decelerator combined. • The control head has been updated with hooks to install into the skyline brackets. 	