

R-Series 1.1Nm | 25mm | 12V

The motorized R-Series roller shade system offers two Automate motors for two tube diameters to suit a variety of applications. Featuring ARC (Automate Radio Communication), the 25mm R-Series Automate system provides an intelligent, Li-ion battery, or a DC powered solution.

**AESTHETIC FEATURES**

- Slim motor head for minimal light gap

**ASSEMBLY / PRODUCTION FEATURES**

- Crown, drive and adapters available to suit two tube sizes

**FUNCTIONAL BENEFITS**

- Leveling control
- Simple limit setting and adjustment
- Favorite position
- 3 operational speed settings
- 2-way RF communication
- ARC protocol for simple programming

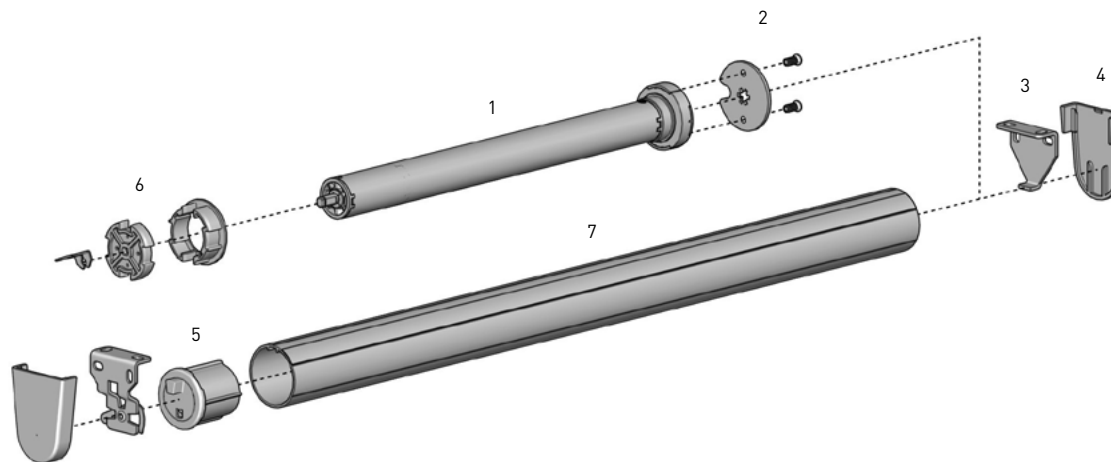

**SYSTEM INDEX**

1	Automate Motor   25mm MTDCBRF25-1.1 - Li-ion 1.1 MTDCRF25-1.1 - DCRF 1.1
2	Motor Adaptor + Screws MTAD-252835-RS + SLAMSCREW
3	Brackets RB360xx - R8 1½" Set RB380xx - R8 2" Set RB390xx - R8 2-⅞" Set
4	Bracket Covers RBPC360xx RBPC380xx
5	Pin End REP03xx - for 1¼" tube REP53xx - for 1½" tube
6	Crown and Drive Kit MTCRDR-25-1.25 - Kit for 1¼" tube MTCRDR-25-1.5 - Kit for 1½" tube
7	Aluminum Tube RTEA3T## - 1¼" tube RTEA4T## - 1½" tube

# - Size  
xxx= Color

**COLOR RANGE**

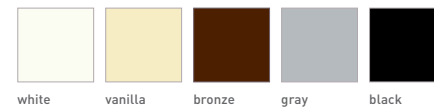

**SYSTEM UPGRADES**

- CASSETTE 80/100/120
- FASCIA 3"/4"/5"
- LINK SYSTEM
- POCKETS 3"/4"/5"/6"

**CONTROL OPTIONS**



**CHARGERS**

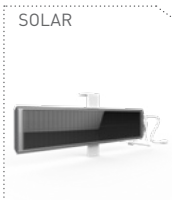

**PRODUCT OPTIONS**



SPECIFICATIONS

DEDUCTION CHART

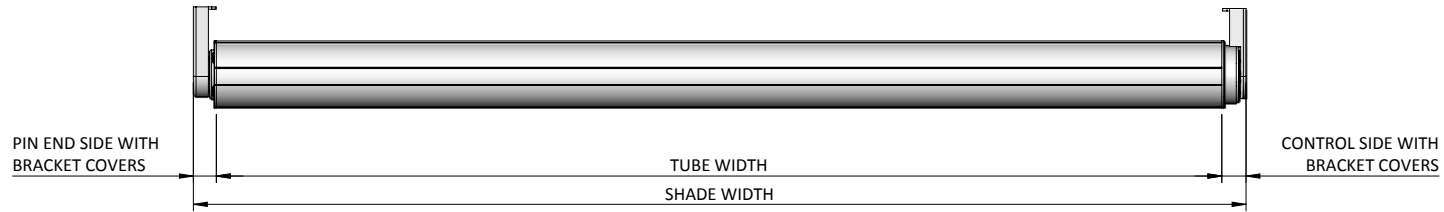

MOTOR	TUBE	BRACKETS	LIGHT GAP			MINIMUM SHADE WIDTH	
			CONTROL END	PIN END	OVERALL		
MTDCBRF25-1.1/ MTDCRF25-1.1	1 1/4"	With Covers	0.75" [19mm]	0.71" [18mm]	1.46" [37mm]	MTDCBRF25-1.1	1.87' [0.570m]
		No Covers	0.67" [17mm]	0.63" [16mm]	1.30" [33mm]		
	1 1/2"	With Covers	0.75" [19mm]	0.67" [17mm]	1.42" [36mm]	MTDCRF25-1.1	1.38' [0.420m]
		No Covers	0.67" [17mm]	0.59" [15mm]	1.26" [32mm]		

MAX ROLL

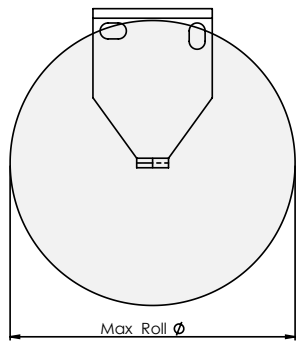

BRACKET	MAX ROLL SIZE
RB360xx	2.57" [69mm]
RB380xx	3.65" [92mm]
RB390xx	4.00" [101mm]

TUBE SPECS.

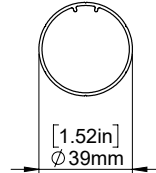

1 1/4" Tube

Code: RTEA3T12 (with tape)  
RTEA3T16 (with tape)

Length 12',16'  
(3.66m, 4.88m)

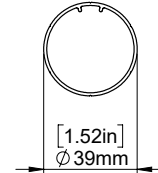

1 1/2" Tube

Code: RTEA4T12 (with tape)  
RTEA4U12  
RTEA4T16 (with tape)  
RTEA4U16

Length 12',16'  
(3.66m, 4.88m)

1 1/4" TUBE		1 1/2" TUBE	
Ø WIDTH	MAX DROP	Ø WIDTH	MAX DROP
7.22' [2.20m]	1.31' [0.40m]*	7.87' [2.40m]	2.62' [0.80m]*
4.59' [1.40m]	13.12' [4.00m]*	5.91' [1.80m]	13.12' [4.00m]*

\* Recommended Max Drop. Exceeding this value may cause fabric tracking issues

SYSTEM CAPACITY

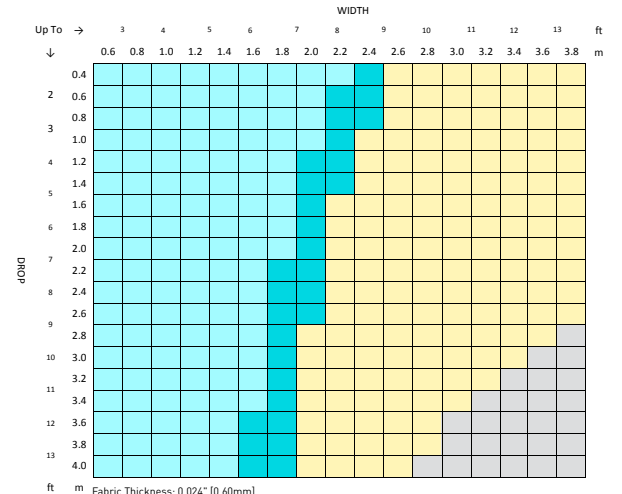

Fabric Thickness: 0.024" [0.60mm]  
Fabric Density: 12.39oz/yd<sup>2</sup> [420gsm]  
Weight Bar: D30 Silent Medium Aluminium Bottom Rail

CONTROL	TUBE	LINK SYSTEM
25mm Motor	RTEA3T## - 1.25"	1.5" ONLY
	RTEA4T## - 1.5"	
	OUTSIDE SPECIFICATIONS	

R-Series 1.1Nm | 25mm

The motorized 25mm 1.1Nm R-Series roller shade system offers two motors for multiple tube diameters to suit a variety of applications. Featuring ARC (Automate Radio Communication), the motorized 25mm 1.1Nm R-Series system provides an intelligent, Li-ion battery powered solution.

**AESTHETICAL FEATURES**

- Thinner Motor Head
- Recessed mounting hooks

**PRODUCTION & ASSEMBLY FEATURES**

- Crown, drive and adapters available to suit multiple tube sizes
- Smaller Motor end deduction

**FUNCTIONAL BENEFITS**

- 5V Micro USB Charging
- Antennae Wire Retention Feature
- Levelling control
- Simple limit setting and adjustment
- Favorite position
- 3 operational speed settings
- ARC protocol for simple programming
- 2-WAY RF communication

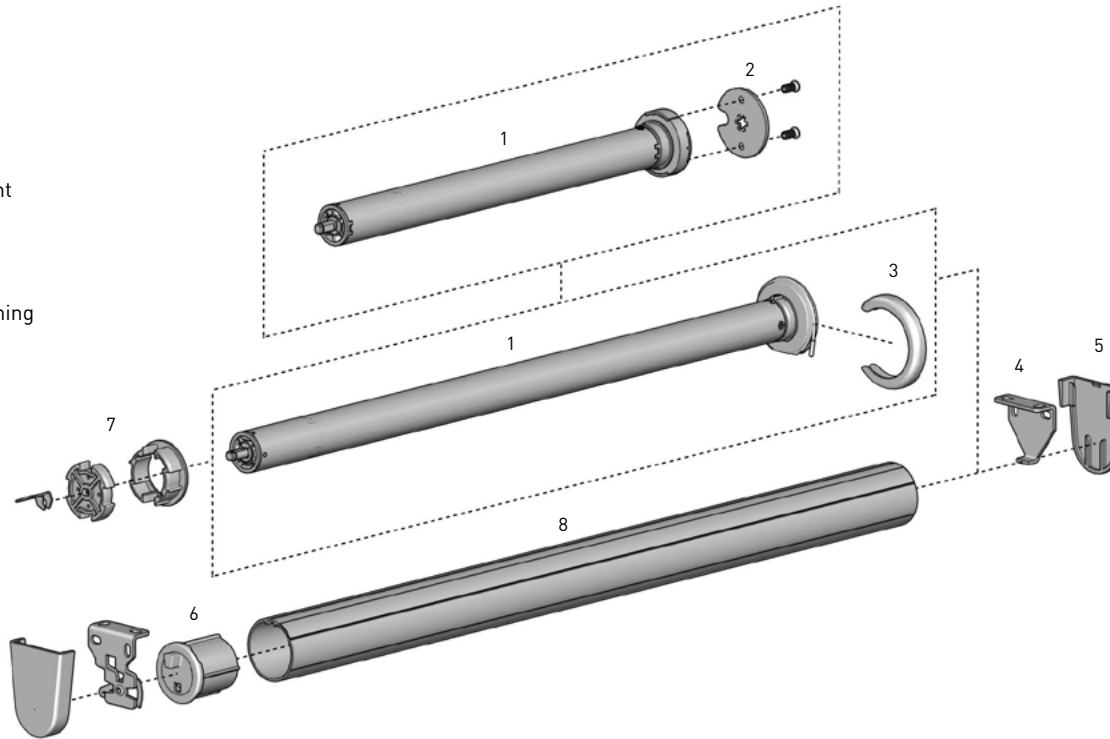

**SYSTEM INDEX**

- 1 Automate Motor | 25mm  
MT01-1325-069001 - Li-ion 1.1 ZERO (SHORT)  
MT01-1325-069002 - Li-ion 1.1 ZERO  
MTDCRF25-1.1 - DCRF 1.1
- 2 Motor Adaptor + Screws - DCRF ONLY  
MTAD-252835-RS + SLAMSCREW
- 3 Motor Cap  
MT03-0205-xxx001 - ZERO ONLY
- 4 Brackets  
RB360xx - R8 1½" Set  
RB380xx - R8 2" Set  
RB390xx - R8 2-7/8" Set  
RB560xx - R16 1½" Set - ZERO ONLY  
RB580xx - R16 2" Set - ZERO ONLY  
RB590xx - R16 27/8" Set - ZERO ONLY
- 5 Bracket Covers  
RBPC360xx  
RBPC380xx
- 6 Pin End  
REP03xx - for 1¼" tube  
REP53xx - for 1½" tube
- 7 Crown and Drive Kit  
MTCRDR-25-1.25 - Kit for 1¼" tube  
MTCRDR-25-1.5 - Kit for 1½" tube
- 8 Aluminum Tube  
RTEA3T## - 1¼" tube  
RTEA4T## - 1½" tube

# - Size  
xxx= Color

**COLOR RANGE**

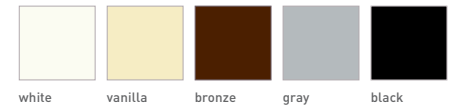

**CONTROL OPTIONS**

<p>REMOTES</p>	<p>WALL SWITCH</p>	<p>SMART HOME</p>	<p>PULSE</p>	<p>ELECTRIC</p>	<p>SOLAR</p>	<p>SUN SENSOR</p>
----------------	--------------------	-------------------	--------------	-----------------	--------------	-------------------

**CHARGERS**

**PRODUCT OPTIONS**

**SYSTEM UPGRADES**

- CASSETTE 80/100/120
- FASCIA 3"/4"/5"
- LINK SYSTEM
- POCKETS 3"/4"/5"/6"



**SPECIFICATIONS**

**DEDUCTION CHART**

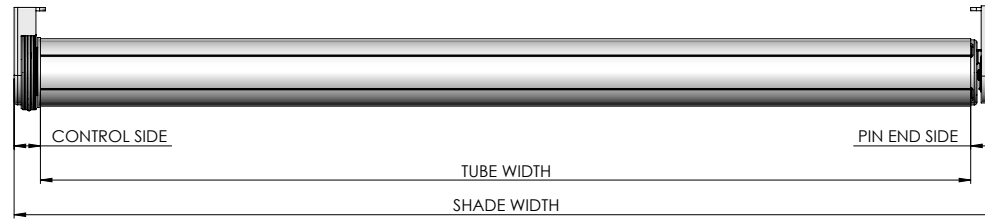

MOTOR	TUBE	BRACKETS	LIGHT GAP			MINIMUM SHADE WIDTH			
			CONTROL END	PIN END	OVERALL				
MT01-1325-069001 MT01-1325-069002	1 1/4"	With Covers	0.59" [15mm]	0.71" [18mm]	1.30" [33mm]	MT01-1325-069001	1.85' [0.565m]		
		No Covers	0.51" [13mm]	0.63" [16mm]	1.14" [29mm]				
MTDCRF25-1.1		With Covers	0.75" [19mm]	0.71" [18mm]	1.46" [37mm]	MT01-1325-069002	2.01' [0.640m]		
		No Covers	0.67" [17mm]	0.63" [16mm]	1.30" [33mm]				
MT01-1325-069001 MT01-1325-069002	1 1/2"	With Covers	0.59" [15mm]	0.71" [18mm]	1.30" [33mm]			MT01-1325-069001	1.85' [0.565m]
		No Covers	0.51" [13mm]	0.63" [16mm]	1.14" [29mm]				
MTDCRF25-1.1		With Covers	0.75" [19mm]	0.67" [17mm]	1.42" [36mm]	MTDCRF25-1.1	1.38' [0.420m]		
		No Covers	0.67" [17mm]	0.59" [15mm]	1.26" [32mm]				

**MAX ROLL**

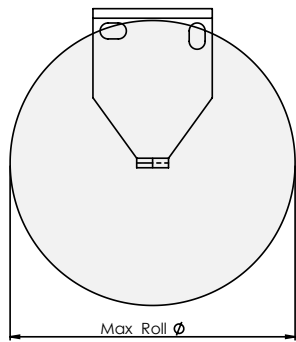

BRACKET	MAX ROLL SIZE
RB360xx	2.57" [69mm]
RB380xx	3.65" [92mm]
RB390xx	4.00" [101mm]
RB560xx	3.00" [76mm]
RB580xx	4.00" [101mm]
RB590xx	5.50" [139mm]

**TUBE SPECS.**

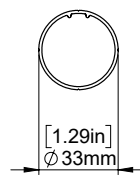

1 1/4" Tube

Code: RTEA3T12 (with tape)  
RTEA3T16 (with tape)

Length 12',16'  
(3.66m, 4.88m)

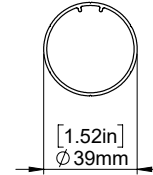

1 1/2" Tube

Code: RTEA4T12 (with tape)  
RTEA4U12  
RTEA4T16 (with tape)  
RTEA4U16

Length 12',16'  
(3.66m, 4.88m)

TUBE		TUBE	
Ø WIDTH	MAX DROP	Ø WIDTH	MAX DROP
7.22' [2.20m]	1.31' [0.40m]*	7.87' [2.40m]	2.62' [0.80m]*
4.59' [1.40m]	13.12' [4.00m]*	5.91' [1.80m]	13.12' [4.00m]*

\* Recommended Max Drop. Exceeding this value may cause fabric tracking issues

**SYSTEM CAPACITY**

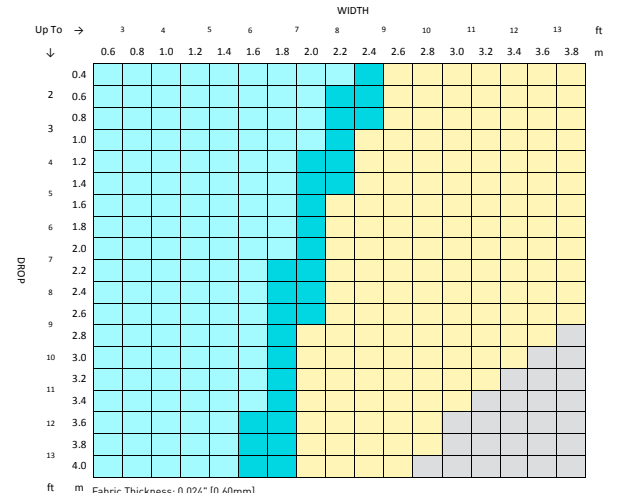

Fabric Thickness: 0.024" [0.60mm]  
Fabric Density: 12.39oz/yd<sup>2</sup> [420gsm]  
Weight Bar: D30 Silent Medium Aluminium Bottom Rail

CONTROL	TUBE	LINK SYSTEM
25mm Motor	RTEA3TH - 1.25"	1.5" ONLY
	RTEA4TH - 1.5"	
	OUTSIDE SPECIFICATIONS	