

OVERVIEW: RB08 MKI CHAIN CONTROL S40/ S45 SYSTEM DETAILS

The progression to the RB08 MKII Chain Control System is due to the implementation of several advancements made in Acmeda's development program, improving the overall performance, function and appearance of the previous design/model.

AESTHETICAL FEATURES

- Smooth / clean aesthetical appearance.
- New ergonomic bracket design with square edge profile.

ASSEMBLY / PRODUCTION FEATURES

- Easy-Lock effortless installation.
- 7mm adjustable Idler Extension.
- Improved installation with self locating grooves.

FUNCTIONAL BENEFITS

- Improved chain retention system, securing chain within mechanism during operation.

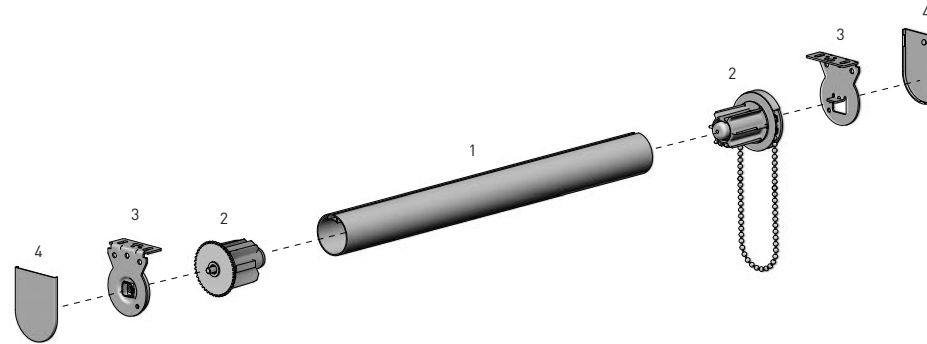

COLOUR RANGE

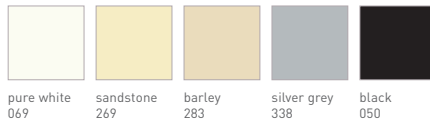

SYSTEM INDEX

- 1 Aluminium Tube - S40/S45
RB91-02##-000##0
- 2 Easy-Lock MKI Chain Winder & Auto idler
RB08-3822-xxx000 - S40
RB08-4322-xxx000 - S45
- 3 Easy-Lock Installation Bracket
RB08-8351-xxx0## - VX [40 & 55mm proj.]
RB08-8314-xxx0## - AX [40 & 55mm proj.]
- 4 Bracket Cover Cap
RB08-4151-xxx0## - VX [40 & 55mm proj.]
RB08-4141-xxx0## - AX [40 & 55mm proj.]

xxx= colour ## = size

SYSTEM OPTIONS

MOUNTING RAIL



COMBO BRACKETS

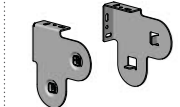

RETRO-FIT BOOSTER



ADD ON SYSTEMS

BOX 90

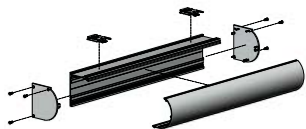

FRS100 VALANCE

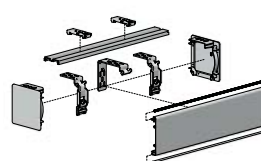

EASY-LINK™

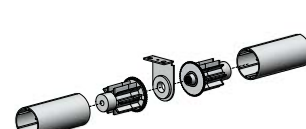

EASY-LINK™ UNI-JOINT



INTERNAL WIRE GUIDE



SPECIFICATIONS: RB08 MKI CHAIN CONTROL S40/ S45 SYSTEM DETAILS

MAX ROLL

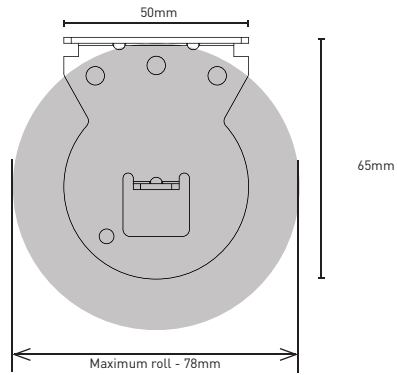

DEDUCTIONS

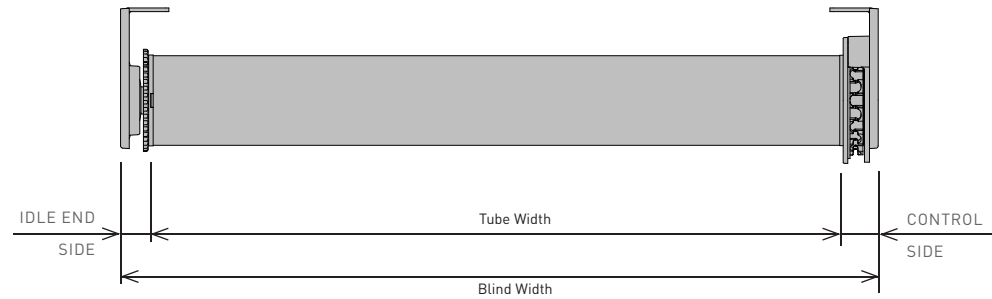

	IDLE END SIDE	CONTROL SIDE	OVERALL DEDUCTION
VX/AX BRACKETS - with covers	15mm [0.59"]	17mm [0.66"]	32mm [1.25"]
VX/AX BRACKETS - withOUT covers	14mm [0.55"]	15mm [0.59"]	29mm [1.14"]

ALUMINIUM TUBES

S40 RANGE

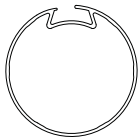

S40 | 39SPLINE
Aluminium Tube

CODE: RB91-0237-000480
with D/S tape RB91-6237-000480
O.D: 39mm
Length: 4.8 metres

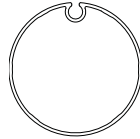

S40 | 39KEYWAY
Aluminium Tube

CODE: RB91-0238-000550
with D/S tape RB91-6238-000550
O.D: 39mm
Length: 5.5 metres

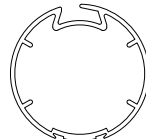

S40 | 40 HEAVY DUTY
Aluminium Tube

CODE: RB91-0240-000550
O.D: 40mm
Length: 5.5 metres

S45 RANGE

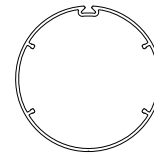

S45 LIGHT
T-Spline Tube

CODE: RB93-0443-000580
with D/S tape RB93-6443-000580
O.D: 43mm
Length: 5.8 metres

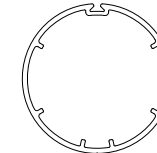

S45 STANDARD
T-Spline Tube

CODE: RB93-0444-000580
with D/S tape RB93-6444-000580
O.D: 44mm
Length: 5.8 metres

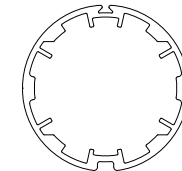

S45 HEAVY DUTY
T-Spline Tube

CODE: RB93-0449-000580
with D/S tape RB93-6449-000580
O.D: 49mm
Length: 5.8 metres

TUBE CAPACITY CHART

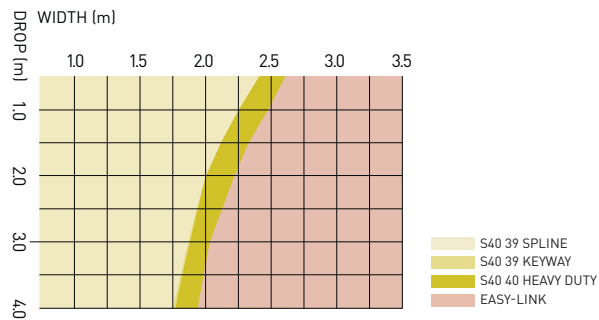

TUBE CAPACITY CHART

