

CF90 CASSETTE/FASCIA

Rollease Acmeda's CF90 Cassette/Fascia add on solution suite offers a comprehensive range of head box styles, controls and side channel options with improved performance functionality and aesthetics. A contemporary round or square headbox, available in fully enclosed or partial fascia, designed to house the S45 Roller Shade chainwinder & motorized control systems. Utilizing versatile hardware, the new cassette suite can be matched with CF90 Edge side channels for improved energy efficiency.

AESTHETICAL FEATURES

- Clean lines and complimentary aesthetics for various applications in round or square finish.
- Both styles available as a fascia or fully enclosed cassette.
- Wall and Ceiling mounting clip options available for installations with minimized light gap.
- End covers designed to overlap cassette front to conceal production blemishes.
- Color matched plastic end covers.

PRODUCTION & ASSEMBLY FEATURES

- Suite utilizes versatile hardware for reduced inventory.
- 2-piece CF90 Edge side channels for improved face/wall and recess/inside mount installation.

FUNCTIONAL BENEFITS

- Compatible with S45 Roller Shade chainwinder & motorized control solutions.
- Co-molded chain guides for smooth and quiet operation.
- CF90 Edge side channels for improved energy efficiency.
- Compatible with Skyline System.

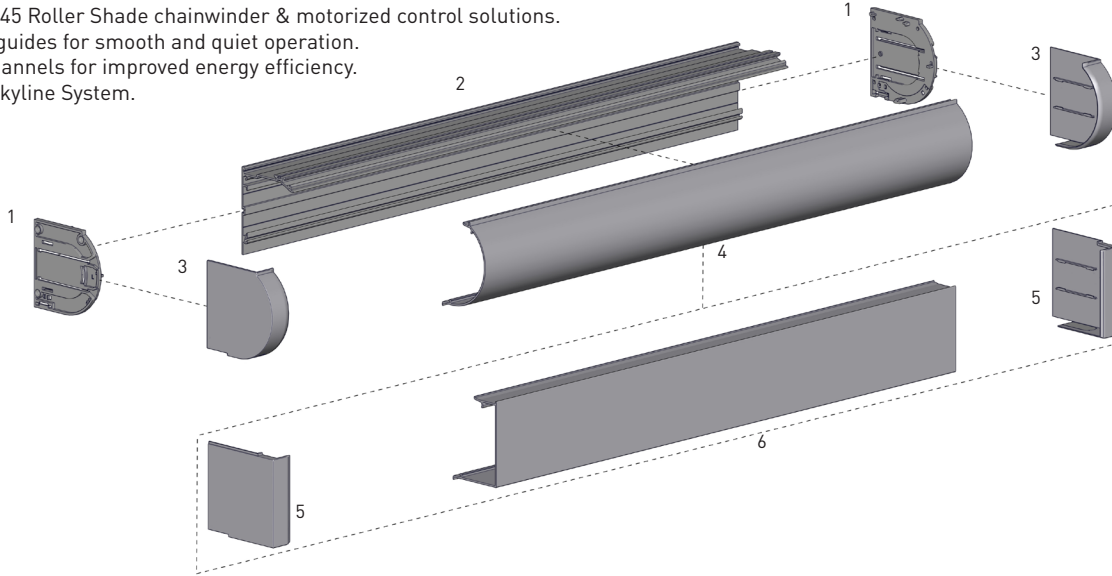

SYSTEM INDEX

1	Cassette 90 End Plate Set
	RC02-0101-xxx090
2	Cassette 90 Back
	RC01-0101-xxx490
3	Cassette 90 Round Cover Set
	RC02-0102-xxx090
4	Cassette 90 Round Cover
	RC01-0102-xxx490
5	Cassette 90 Square Cover Set
	RC02-0103-xxx090
6	Cassette 90 Square Cover
	RC01-0103-xxx490

xxx= colour

COLOR RANGE



CONTROL OPTIONS

CHAIN CONTROL S40
[AU ONLY] / S45 /
SKYLINE



AERO SINGLE AND
ESU/ESW



MOTORIZED



SYSTEM OPTIONS

ROUND FASCIA

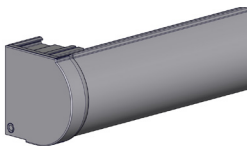

SQUARE FASCIA

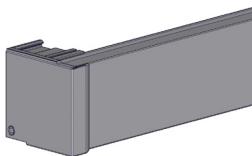

TOP MOUNTING CLIP



FACE/WALL MOUNTING CLIP



SYSTEM UPGRADES

CF90 EDGE

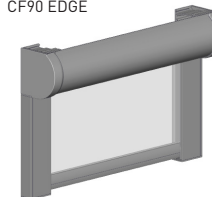

SPECIFICATIONS

MAX ROLL - ROUND CASSETTE

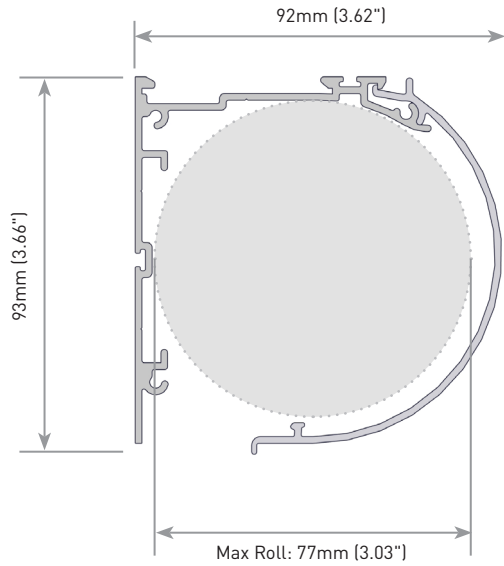

MAX ROLL - SQUARE CASSETTE

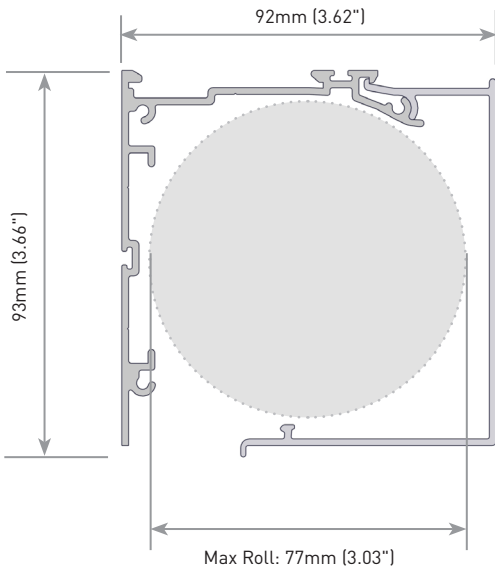

DEDUCTION

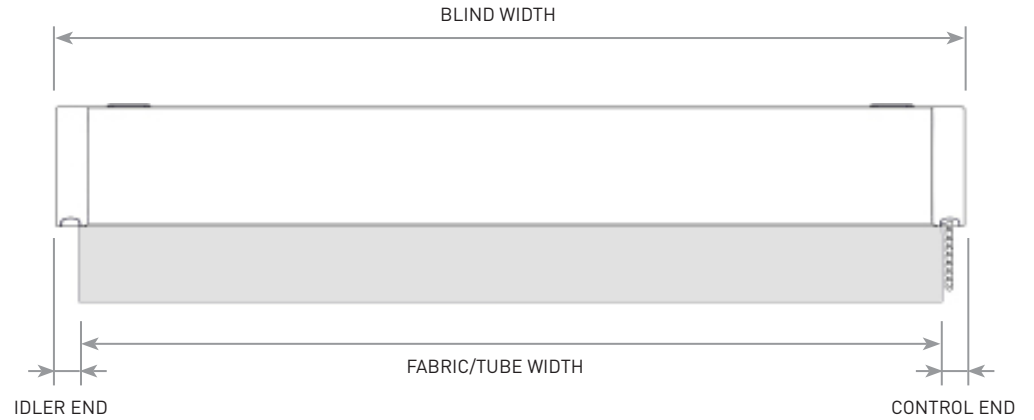

IDLER END		CONTROL END					
		SPRING	MOTORIZATION			CHAINWINDER	
RB09	SLPEV653	RB01	ALTUS/SONESSE	ROLLUP WIREFREE	SONESSE 30	RB09	SL15
18mm (0.709")	19mm* (0.748")	19mm (0.748")	22mm (0.866")	18mm (0.709")	20mm (0.787")	18mm (0.709")	20mm (0.787")

*Add 1mm (0.039") for HD Pin End.