

VERTICALS

| | | |
|------------------|--------------------------|----|
| SECTION 1 | CORD/WAND CONTROL | |
| | VA08 Slim Round 25 | 20 |
| SECTION 2 | ACCESSORIES | |
| | Accessories | 24 |

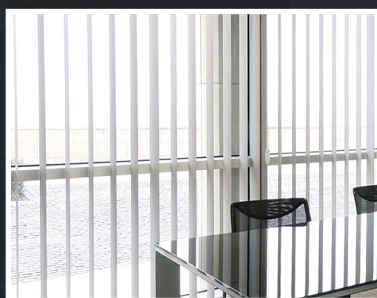

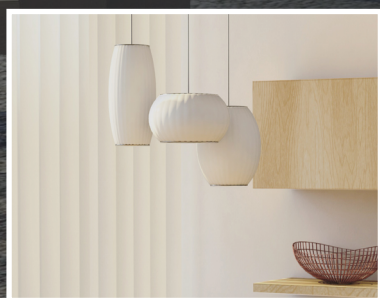
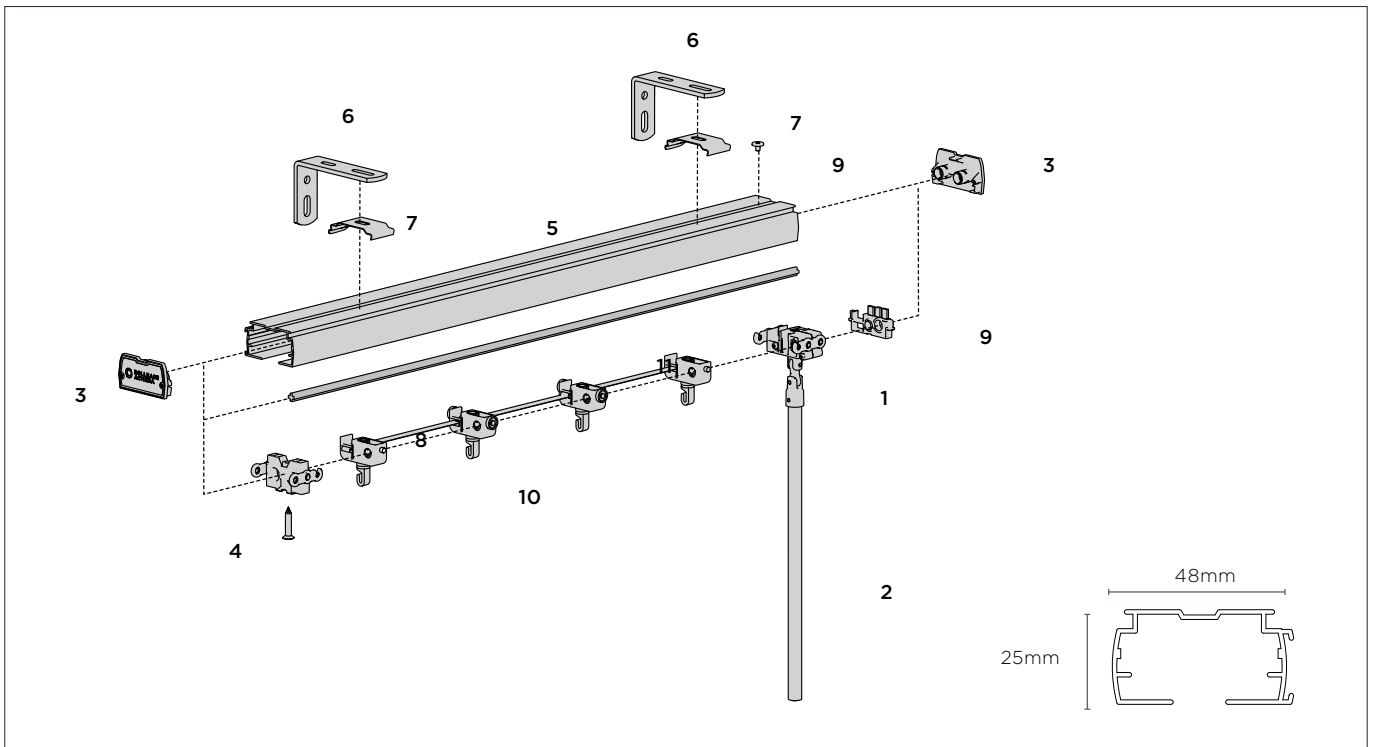

COLOUR RANGE



Pure White Sandstone Silver Grey Anodised Black

CARRIER EXTENSION + PLASTIC J HOOK 16

FLAT EXTENDER BAR 17

FRS100 VALANCE p.84

FRS120 VALANCE p.84

VERTICAL WAND CONTROL UNIT

Universal

| | |
|--------|------------------|
| STYLE. | OFFSET |
| CODE. | VA01-0210-069000 |
| PACK. | 25 400 Sets |

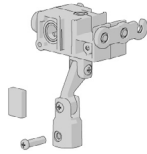

COLOUR. Off White 066, Pure White 069
USE WITH. Vertical Head Rail, Carriers, Wand, Tiltrod Support

1

INSTALLATION BRACKETS · 40MM X 75MM

| | | |
|-------|------------------|------------------|
| TYPE. | silver 020 | snow white 062 |
| CODE. | VA01-1607-020075 | VA01-1607-062075 |
| PACK. | 400 5200 Pcs | 400 5200 Pcs |

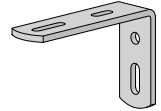

COLOUR. Silver 020, Snow White 062
USE WITH. Spring Ceiling Clips

6b

ALUMINIUM WAND

| | | | |
|-------|------------------|------------------|------------------|
| TYPE. | 50cm | 75cm | 150cm |
| CODE. | VA91-0218-069050 | VA91-0218-xxx075 | VA91-0218-xxx150 |
| PACK. | 25 100 Lengths | 25 100 Lengths | 25 100 Lengths |



COLOUR. Anodised 020, Pure White 069, Black 050, Sandstone 269
USE WITH. Wand Control Unit

2a

INSTALLATION BRACKETS · 40MM X 95MM

| | | |
|-------|------------------|------------------|
| TYPE. | silver 020 | snow white 062 |
| CODE. | VA01-1607-020095 | VA01-1607-062095 |
| PACK. | 300 5100 Pcs | 300 5100 Pcs |

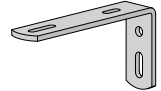

COLOUR. Silver 020, Snow White 062
USE WITH. Spring Ceiling Clips

6c

ALUMINIUM WAND CAP

| | |
|-------|------------------|
| CODE. | VA91-0318-001000 |
| PACK. | 100 2000 Pcs |

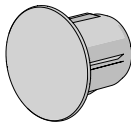

COLOUR. Clear 001
USE WITH. Aluminium wand

2b

INSTALLATION BRACKETS · 40MM X 115MM

| | | |
|-------|------------------|------------------|
| TYPE. | silver 020 | snow white 062 |
| CODE. | VA01-1607-020115 | VA01-1607-062115 |
| PACK. | 300 5100 Pcs | 300 5100 Pcs |

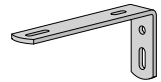

COLOUR. Silver 020, Snow White 062
USE WITH. Spring Ceiling Clips

6d

VA08 VERTICAL WAND CONTROL END CAP + SCREWS

Slim Round 25

| | |
|-------|------------------|
| CODE. | VA08-0238-xxx000 |
| PACK. | 50 500 Kits |

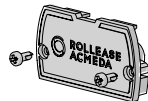

COLOUR. Black 050, Pure White 069, Sandstone 269, Silv. Grey 338
USE WITH. Vertical Head Rail

3

SPRING CEILING CLIP

| | |
|-------|---------------------|
| TYPE. | 40mm - Acmeda Style |
| CODE. | VA01-3002-025040 |
| PACK. | 500 2000 Pcs |



COLOUR. Zinc Plated 025
USE WITH. Vertical Head Rail, Installation Brackets

7

VERTICAL CARRIER ANCHOR + SCREW

| | |
|-------|------------------|
| CODE. | VA08-0268-069000 |
| PACK. | 50 500 Kits |

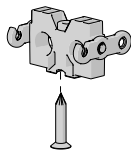

COLOUR. Pure White 069
USE WITH. Carrier Spacer, Vertical Head Rail, Tiltrod

4

FACE FIX ASSEMBLED VERTICAL BRACKET - 75MM

| | |
|-------|------------------|
| CODE. | VA01-1617-xxx075 |
| PACK. | 200 1000 Pcs |

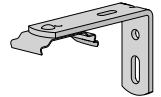

COLOUR. Zinc Plated 025, Black 050, Pure White 069, Sandstone 269
USE WITH. Vertical Head Rail, Tiltrod

-

ALUMINIUM HEAD RAIL SLIM ROUND 25 | VALANCED

| | |
|-------|------------------|
| CODE. | VA08-0112-xxx580 |
| PACK. | 8 96 Lengths |

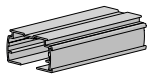

COLOUR. Nat. Anod 020, Black 050, Pure White 069, Sandstone 269
USE WITH. Wand Control End Cap, Planetary Geared Unit

5a

FACE FIX ASSEMBLED VERTICAL BRACKET - 95MM

| | |
|-------|------------------|
| CODE. | VA01-1617-xxx095 |
| PACK. | 200 1000 Pcs |

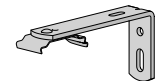

COLOUR. Zinc Plated 025, Black 050, Pure White 069, Sandstone 269
USE WITH. Vertical Head Rail

-

VERTICAL HEAD RAIL SLIM 25 | 5.8 METRE

| | |
|-------|------------------|
| CODE. | VA08-0114-xxx580 |
| PACK. | 6 90 Lengths |

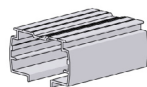

COLOUR. Anodised 020, Black 050, Pure White 069

5b

ALUMINIUM TILTROD 3 WAY | 6MM

| | |
|-------|-------------------|
| CODE. | VA01-0163-000580 |
| PACK. | 50 1200 Lengths |



COLOUR. Mill Finish 000
USE WITH. Wand Control Unit, Carrier Anchor, Wand control end cap, Tiltrod Support

8

INSTALLATION BRACKETS | 40MM X 40MM

| | |
|-------|------------------|
| TYPE. | silver 020 |
| CODE. | VA01-1607-020040 |
| PACK. | 400 5200 Pcs |

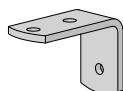

COLOUR. Silver 020
USE WITH. Spring Ceiling Clips

6a

TILTROD SUPPORT + SCREW

| | |
|-------|------------------|
| CODE. | VA01-0612-069000 |
| PACK. | 250 3000 Sets |

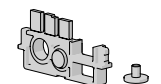

COLOUR. Pure White 069
USE WITH. Vertical Head Rail, Tiltrod

9a

SLIM MAGNETIC TILTROD SUPPORT & METAL PLATE

9b

| | |
|-------|------------------|
| CODE. | VA01-0609-069000 |
| PACK. | 250 3000 Sets |

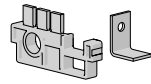

COLOUR. Pure White 069
USE WITH. Vertical Head Rail, Tiltrod, VA08 Planetary Geared Control

MAGNETIC TILTROD SUPPORT & METAL PLATE

9c

| | |
|-------|------------------|
| CODE. | VA01-0608-062002 |
| PACK. | 250 3000 Sets |

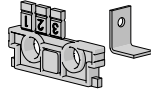

COLOUR. Snow White 062
USE WITH. Vertical Tiltrod, VA08 Planetary Geared Control

CARRIER EXTENSION + PLASTIC J HOOK

16

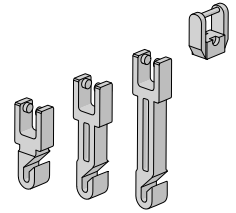

| | | | |
|-------|------------------|------------------|------------------|
| TYPE. | 30mm | 40mm | 50mm |
| CODE. | VA01-3630-060000 | VA01-3640-060000 | VA01-3650-060000 |
| PACK. | 200 2000 Sets | 200 2000 Sets | 200 2000 Sets |

COLOUR. Natural White 060
USE WITH. Carriers

CARRIER SPACER | 2 WAY LOWER HOUSING
J Hook

10a

| | | |
|-------|-------------------|------------------|
| TYPE. | STEEL | PLASTIC |
| CODE. | VA01-0322-2S JL60 | VA01-0324-2PJL60 |
| PACK. | 500 4000 Pcs | 500 4000 Pcs |

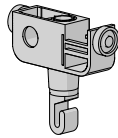

USE WITH. Vertical Head Rail, Aluminium Tiltrod, Link Spacers

STEEL SEEGER STOP RING

| | |
|-------|------------------|
| CODE. | VA01-1005-050000 |
| PACK. | 1000 10000 Pcs |



COLOUR. Black 050
USE WITH. Aluminium Tiltrod, Planetary Geared Control Unit

SLIMLINE CARRIER SPACER | 2 WAY LOWER HOUSING
J Hook

10b

| | | |
|-------|-------------------|------------------|
| TYPE. | METAL | PLASTIC |
| CODE. | VA02-0322-2S JL60 | VA02-0324-2PJL60 |
| PACK. | 500 4000 Pcs | 500 4000 Pcs |

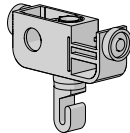

USE WITH. Vertical Head Rail, Aluminium Tiltrod, Link Spacers

CORD DRIVE RUNNERS WU

| | |
|-------|------------------|
| CODE. | VA01-0703-062000 |
| PACK. | 500 2000 Sets |

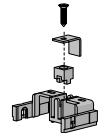

COLOUR. Snow White 062
USE WITH. Carriers - Standard & Lower Housing

METAL LINK SPACER

11a

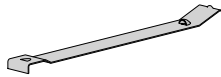

| | | | |
|-------|------------------|------------------|--|
| SIZE. | 89mm slat | 100mm slat | 127mm slat |
| PITCH | 74,75,76,78 & 79 | 86 & 89 | 102,105,109,110, 111, 112, 113,114,115,116 & 117 |
| CODE. | VA01-0403-010xxx | VA01-0404-010xxx | VA01-0405-010xxx |
| PACK. | 1000 10000 Pcs | 1000 10000 Pcs | 1000 10000 Pcs |

USE WITH. Carriers - Metal Spacers

FLAT EXTENDER BAR | 100MM

17

| | |
|-------|------------------|
| CODE. | VA01-1608-020100 |
| PACK. | 500 5000 Pcs |

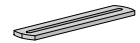

COLOUR. Silver 020
USE WITH. Installation Brackets

SHAFT FASTENING SCREW

| | |
|-------|------------------|
| CODE. | VA01-1102-020000 |
| PACK. | 500 10000 Pcs |



COLOUR. Silver 020
USE WITH. Slim Magnetic Tiltrod Support, Vertical Head Rail

PLASTIC LINK SPACER

11b

| | | |
|--------|------------------|------------------|
| SIZE. | 89mm slat | 127mm slat |
| PITCH. | 79 | 113, 115 |
| CODE. | VA01-0413-060xxx | VA01-0415-06011x |
| PACK. | 500 10000 Pcs | 500 20000 Pcs |



USE WITH. Carriers - Plastic Spacers

TILTROD SUPPORT DRILL TEMPLATE

| | |
|-------|------------------|
| CODE. | VA01-0611-010000 |
| PACK. | 1 5 Pcs |



COLOUR. Silver 010
USE WITH. Tiltrod Support, Vertical Head Rail

VA08 PLANETARY GEARED CONTROL UNIT
Slim Round 25 | 10mm

| | |
|-------|------------------|
| CODE. | VA08-0203-069021 |
| PACK. | 100 400 Sets |

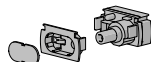

COLOUR. Pure White 069
USE WITH. Vertical Head Rail, Chain and Braided cord

This page has been left blank intentionally

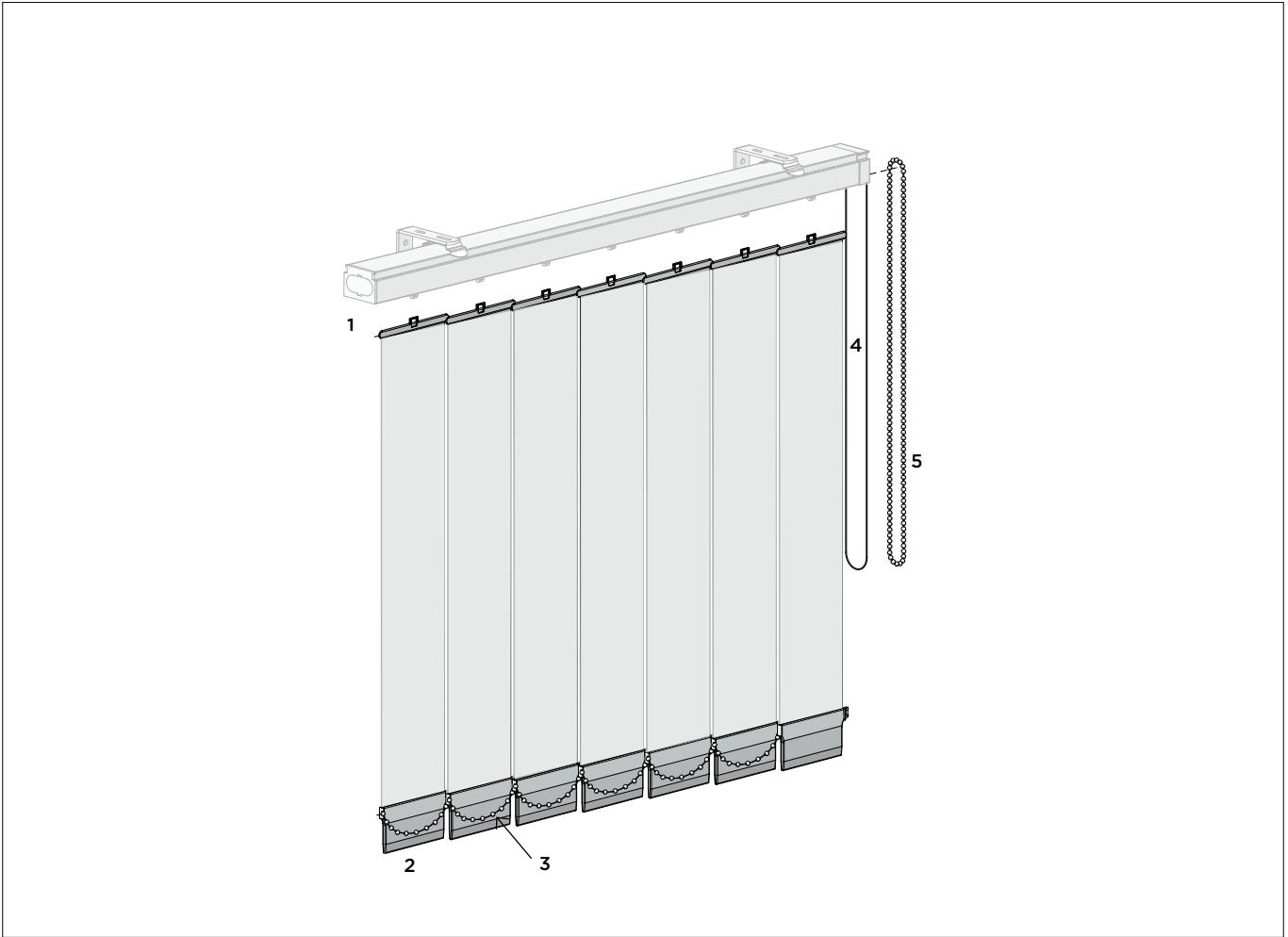

COLOUR RANGE



Snow White Beige Smokey Apo Grey

COMPONENTS

PLASTIC SLAT HANGER 1

| TYPE. | 89mm | 100mm | 127mm |
|-------|------------------|------------------|------------------|
| CODE. | VA01-2001-060089 | VA01-2001-060100 | VA01-2001-060127 |
| PACK. | 1000 10000 Pcs | 1000 10000 Pcs | 1000 10000 Pcs |

COLOUR. Natural White 060
USE WITH. Carriers

BOTTOM WEIGHTS 2a

| TYPE. | 63 mm | | |
|-------|------------------|--|--|
| CODE. | VA01-4001-310063 | | |
| PACK. | 350 24000 Pcs | | |

| TYPE. | 89mm | 100mm | 127mm |
|-------|------------------|------------------|------------------|
| CODE. | VA01-4001-310089 | VA01-4001-310100 | VA01-4001-310127 |
| PACK. | 500 20000 Pcs | 300 20000 Pcs | 250 15000 Pcs |

COLOUR. Smokey 310
USE WITH. Link Chain

CHAINLESS BOTTOM WEIGHTS

2b

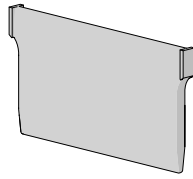

| TYPE. | 89mm | 100mm | 127mm |
|-------|------------------|------------------|------------------|
| CODE. | VA01-4011-310089 | VA01-4011-310100 | VA01-4011-310127 |
| PACK. | 400 20000 Pcs | 300 21000 Pcs | 300 15000 Pcs |

COLOUR. Smokey 310

SEW-IN BOTTOM WEIGHTS | METAL

2c

89mm - 59 mm x 28 mm
100mm - 70 mm x 28 mm
127mm - 97 mm x 28 mm

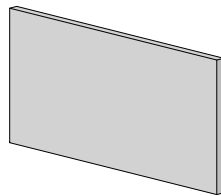

| TYPE. | 89mm | 100mm | 127mm |
|-------|------------------|------------------|------------------|
| CODE. | VA01-4021-025089 | VA01-4021-025100 | VA01-4021-025127 |
| PACK. | 150 600 Pcs | 100 400 Pcs | 50 200 Pcs |

COLOUR. Silver Zinc Plated 025

LINK CHAIN ST | PLASTIC

3

| TYPE. | 89/100mm | 127mm |
|-------|-------------------|-------------------|
| CODE. | VA01-1801-xxx089 | VA01-1801-xxx127 |
| PACK. | 500 4000 Metres | 500 4000 Metres |

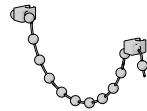

COLOUR. Snow White 062, Smoky Grey 310
USE WITH. Bottom Weights

AC01 | BRAIDED CORD 1.8MM | 16PLY

4a

| TYPE. | 1.8mm |
|-------|-------------------|
| CODE. | AC01-1816-062500 |
| PACK. | 500 6000 Metres |

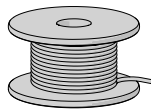

COLOUR. Snow White 062

AC01 | BRAIDED CORD 2.1MM | 16PLY

4b

| TYPE. | 2.1mm |
|-------|-------------------|
| CODE. | AC01-2116-xxx500 |
| PACK. | 500 6000 Metres |

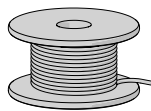

COLOUR. Pure White 069, Black + White 120

PRE LOOPED METAL ROTATION CHAIN | STEEL

5a

#10/4.5 Double Bead - 6p/48-49

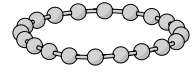

| SIZE. | 50cm |
|-------|------------------|
| CODE. | VA01-1401-S20050 |
| PACK. | 10 500 Pcs |

| SIZE. | 75cm | 100cm | 125cm |
|-------|------------------|------------------|------------------|
| CODE. | VA01-1401-S20075 | VA01-1401-S20100 | VA01-1401-S20125 |
| PACK. | 10 500 Pcs | 10 400 Pcs | 10 300 Pcs |

| SIZE. | 150cm | 175cm | 200cm |
|-------|------------------|------------------|------------------|
| CODE. | VA01-1401-S20150 | VA01-1401-S20175 | VA01-1401-S20200 |
| PACK. | 10 250 Pcs | 10 200 Pcs | 10 200 Pcs |

USE WITH. Planetary Geared Control Unit

PRE LOOPED METAL ROTATION CHAIN STAINLESS STEEL

5b

#10/4.5 Double Bead - 6p/48-49

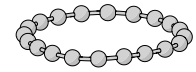

| SIZE. | 50cm |
|-------|------------------|
| CODE. | VA01-1401-X10050 |
| PACK. | 10 500 Pcs |

| SIZE. | 75cm | 100cm | 125cm |
|-------|------------------|------------------|------------------|
| CODE. | VA01-1401-X10075 | VA01-1401-X10100 | VA01-1401-X10125 |
| PACK. | 10 500 Pcs | 10 400 Pcs | 10 300 Pcs |

| SIZE. | 150cm | 175cm | 200cm |
|-------|------------------|------------------|------------------|
| CODE. | VA01-1401-X10150 | VA01-1401-X10175 | VA01-1401-X10200 |
| PACK. | 10 250 Pcs | 10 200 Pcs | 10 200 Pcs |

USE WITH. Planetary Geared Control Unit

METAL ROTATION CHAIN | 150LM ROLLS

5c

#10/4.5 Double Bead - 6p/48-49

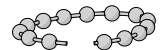

| SIZE. | Brass - silver | Aluminium - silver |
|-------|------------------|--------------------|
| CODE. | VA01-1401-020B45 | VA01-1401-020A45 |
| PACK. | 150 600 Metres | 150 600 Metres |

| SIZE. | Nickel Plated - silver | Stainless Steel |
|-------|------------------------|------------------|
| CODE. | VA01-1401-020S45 | VA01-1401-010X45 |
| PACK. | 150 600 Metres | 150 600 Metres |

USE WITH. Planetary Geared Control Unit

PRE LOOPED PLASTIC ROTATION CHAIN | COLOURS

#10/4.5 Double Bead - 6p/48-49 [*=INDENT]

5d

| | |
|-------|------------------|
| SIZE. | 50cm |
| CODE. | VA01-1406-xxx050 |
| PACK. | 10 500 Pcs |

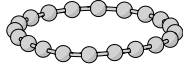

| | | | |
|-------|------------------|------------------|------------------|
| SIZE. | 75cm | 100cm | 125cm |
| CODE. | VA01-1406-xxx075 | VA01-1406-xxx100 | VA01-1406-xxx125 |
| PACK. | 10 500 Pcs | 10 500 Pcs | 10 500 Pcs |

| | | | |
|-------|------------------|------------------|------------------|
| SIZE. | 150cm | 175cm | 200cm |
| CODE. | VA01-1406-xxx150 | VA01-1406-xxx175 | VA01-1406-xxx200 |
| PACK. | 10 500 Pcs | 10 500 Pcs | 10 400 Pcs |

| | | |
|-------|------------------|------------------|
| SIZE. | 225cm* | 250cm* |
| CODE. | VA01-1406-xxx225 | VA01-1406-xxx250 |
| PACK. | 10 400 Pcs | 10 200 Pcs |

COLOUR. Black 050, Pure White 069, Silver Grey 338, Birch White 412, Barley 283
USE WITH. Planetary Geared Control Unit

PLASTIC ROTATION CHAIN | 150LM ROLLS

#10/4.5 Double Bead | 6p/48-49

5e

| | |
|-------|-------------------|
| CODE. | VA01-1406-xxx000 |
| PACK. | 150 1200 Metres |

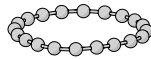

COLOUR. Black 050, Pure White 069, Silver Grey 338, Birch White 412, Barley 283
USE WITH. Planetary Geared Control Unit

METAL CHAIN CONNECTOR

#10/4.5

| | | |
|-------|------------------|------------------|
| TYPE. | Stainless Steel | Steel |
| CODE. | VA01-1521-010000 | VA01-1521-024000 |
| PACK. | 1000 25000 Pcs | 1000 25000 Pcs |

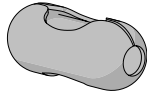

COLOUR. Stainless Steel 010, Silver Zinc Plated 024
USE WITH. #10 Rotation Chains - Plastic or Metal

PLASTIC CHAIN CONNECTOR

#10/4.5

| | |
|-------|------------------|
| CODE. | VA01-1501-xxx000 |
| PACK. | 1000 20000 Pcs |

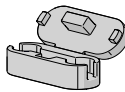

COLOUR. Clear 001, Pure White 069, Barley 283
USE WITH. #10 Plastic Rotation Chain

CHAIN TENSIONERS & SCREWS

Face/Wall Fix

| | |
|-------|------------------|
| CODE. | RB91-1321-xxx000 |
| PACK. | 25 400 Sets |

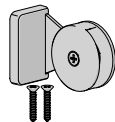

COLOUR. Black 050, Pure White 069, Silver Grey 338, Barley 283, Sandstone 269
USE WITH. #10 Rotation Chains - Plastic or Metal, #10 Chain Stopper - Ball

CHAIN TENSIONERS & SCREWS

Recess Fix

| | |
|-------|------------------|
| CODE. | RB91-1322-xxx000 |
| PACK. | 25 400 Sets |

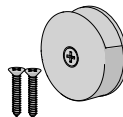

COLOUR. Black 050, Pure White 069, Sandstone 269, Barley 283, Silver Grey 338
USE WITH. #10 Rotation Chains - Plastic or Metal, #10 Chain Stopper - Ball

CHAINHOLD TD TENSIONER + SCREWS

| | |
|-------|------------------|
| CODE. | RB91-1331-069000 |
| PACK. | 25 400 Sets |

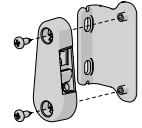

COLOUR. Pure White 069
USE WITH. #10 Rotation Chains - Plastic or Metal

CHAIN TENSIONING HOOK + SCREW | UNIVERSAL

Universal Fix

| | |
|-------|------------------|
| CODE. | RB91-1325-xxx000 |
| PACK. | 50 1000 Sets |

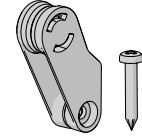

COLOUR. Clear 001, Pure White 069
USE WITH. #10 Rotation Chains - Plastic or Metal

CHAIN TENSIONING HOOK 'SMALL' & SCREW

Universal Fix

| | |
|-------|------------------|
| CODE. | SS91-1312-001040 |
| PACK. | 100 2000 Sets |

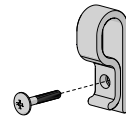

COLOUR. Clear 000
USE WITH. #10 Rotation Chains - Plastic or Metal

PLASTIC CORD CLEAT & SCREWS

80mm

| | |
|-------|------------------|
| TYPE. | clear 001 |
| CODE. | SS91-3411-001080 |
| PACK. | 100 2000 Sets |



USE WITH. Braided Cord

SAFETY WARNING DEVICE

Hang Tag & Fastening Tie

- Price not subject to group discount

| | |
|-------|------------------|
| CODE. | HD91-0105-000002 |
| PACK. | 250 5000 Pcs |



USE WITH. #10 Rotation Chain - Plastic or Metal

SAFETY WARNING DEVICE

Packaging Sticker Label

- Price not subject to group discount

| | |
|-------|------------------|
| CODE. | HD91-0116-000001 |
| PACK. | 500 5000 Pcs |

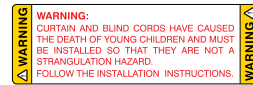

WARNING: CURTAIN AND BLIND CORDS HAVE CAUSED THE DEATH OF YOUNG CHILDREN AND MUST BE INSTALLED SO THAT THEY ARE NOT A STRANGULATION HAZARD. FOLLOW THE INSTALLATION INSTRUCTIONS. **WARNING**

METAL ROTATION CHAIN JOINING PLIERS

S/s, Steel & brass #10/4.5

- Price not subject to group discount

| | |
|-------|------------------|
| CODE. | TM10-0282-000045 |
| PACK. | 1 Pc |



COLOUR. Silver 020
USE WITH. #10 / 4.5mm Ball Metal Rotation Chain

SILICONE SPRAY AEROSOL 300 GRAMS

- Price not subject to group discount

| | |
|-------|------------------|
| CODE. | HD91-0301-000000 |
| PACK. | 12 120 Pcs |



USE WITH. Aluminium Head Rail & Aluminium Tiltrod