

SPECIFICATIONS: S40/45 SPRING SYSTEM INFORMATION

MAX ROLL

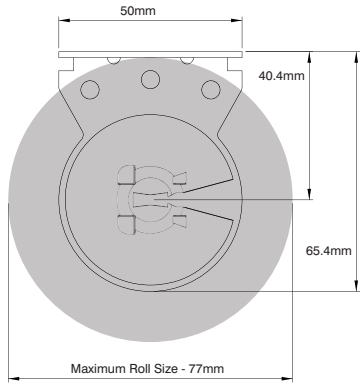

SPRING	SIZE	LENGTH	MINIMUM BLIND WIDTH
Stop Spring S40 & S45	Junior	471mm	543mm
	Standard	696mm	768mm
NO Stop Spring S40 & S45	Junior	471mm	543mm
	Standard	696mm	768mm

DEDUCTIONS

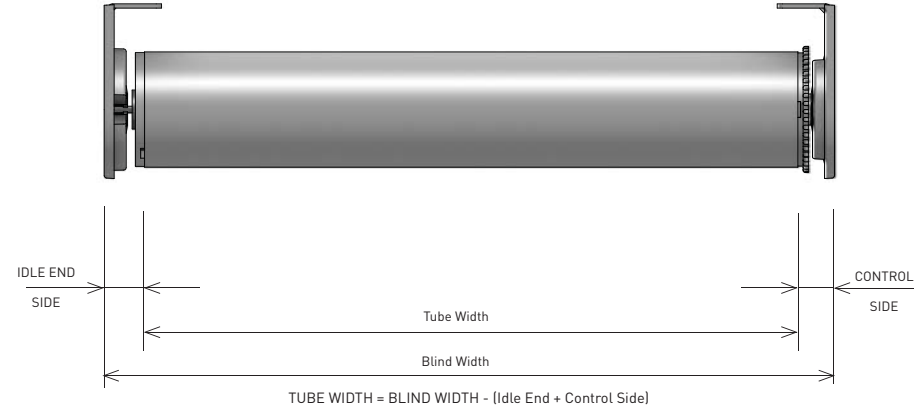

	IDLE END SIDE	CONTROL SIDE	OVERALL DEDUCTION
VX Brackets 40p - No Covers	15.0mm (0.59")	15.0mm (0.59")	30.0mm (1.18")
VX Brackets 40 p - with Cover Caps	16.0mm (0.62")	16.0mm (0.62")	32.0mm (1.25")
Combo Brackets	15.0mm (0.59")	15.0mm (0.59")	30.0mm (1.18")

ALUMINIUM TUBES

S40 RANGE



S40 | 39SPLINE
Aluminium Tube

CODE: RB91-0237-000480
with D/S tape RB91-6237-000480
O.D: 39mm
Length: 4.8 metres

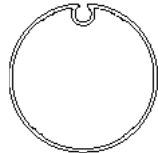

S40 | 39KEYWAY
Aluminium Tube

CODE: RB91-0238-000550
with D/S tape RB91-6238-000550
O.D: 39mm
Length: 5.5 metres

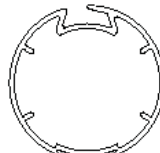

S40 | 40 HEAVY DUTY
Aluminium Tube

CODE: RB91-0240-000550
O.D: 40mm
Length: 5.5 metres

S45 RANGE

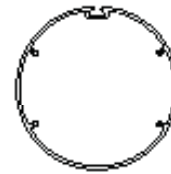

S45 LIGHT
T-Spline Tube

CODE: RB93-0443-000580
with D/S tape RB93-6443-000580
O.D: 43mm
Length: 5.8 metres

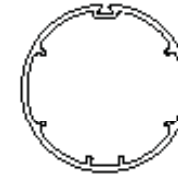

S45 HEAVY DUTY
T-Spline Tube

CODE: RB93-0444-000580
with D/S tape RB93-6444-000580
O.D: 44mm
Length: 5.8 metres

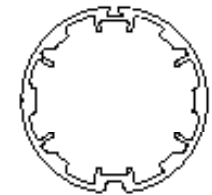

S45 HEAVY DUTY
T-Spline Tube

CODE: RB93-0449-000580
with D/S tape RB93-6449-000580
O.D: 49mm
Length: 5.8 metres