

Piuma

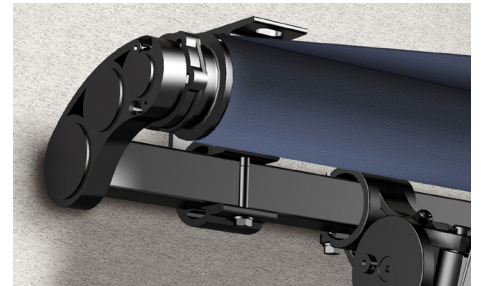
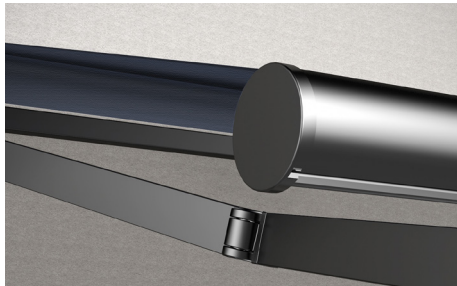

FEATURES

- Class 2 wind resistance according to European standard EN 13561
- Certified Italian Stainless steel screws and pins
- Wall and ceiling installation
- Continuous micrometric regulation of inclination
- Inclination between 0° and 90°
- FUSION arms with DATSystem
- Maximum size of a single section: 700x304 cm
- Manually operated or motorised
- Available with protective hood

COLOUR RANGE

Graphite White



FABRIC PROTECTION HOOD

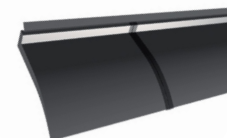

CABLE ARM SYSTEM

YUKI features the Fusion Arm with a tensioned, spring loaded, double stainless steel cable, PVC coated for added protection against corrosion. The Dynamic Arm Torsion system is specifically designed to prevent fabric damage and sagging by maintaining constant tension.

FEATURES

- Outstanding mechanical performance.
- Fabric damage prevention.
- Maximum durability.
- Arms can be adjusted to tilt in single degree increments.

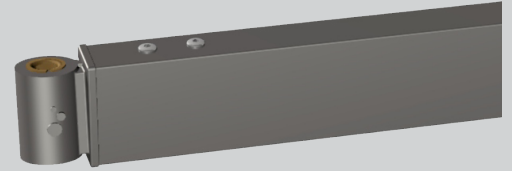

DIMENSIONS

WALL / TOP FIX
0° inclination

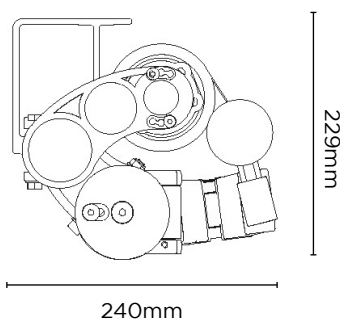

90° inclination

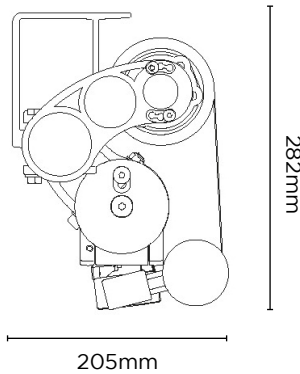

ARM PROJECTION

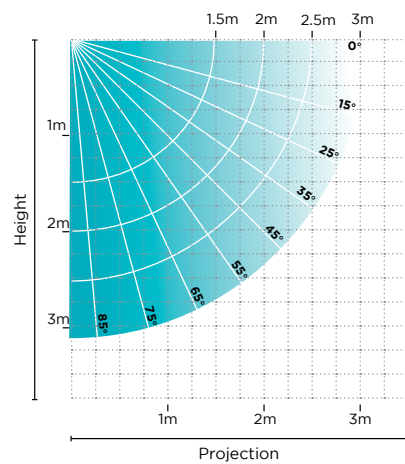

SYSTEM CAPACITY

Max width: 7m
Max projection: 3.04m

Wind Resistance: Class 2,
EN 13561 (600 cm x 265 cm)

Independently tested and approved by



AUTOMATE MOTORISATION

Easily control your motorised awning with a remote control or smart phone device using the Automate App & Pulse 2 hub. Control awnings from anywhere in the world, set scenes and timers for automatic control and always know what your awnings are doing thanks to ARC bi-directional live feedback. The Pulse 2 also integrates with smart voice-assistants such as Google Assistant, Amazon Alexa and now Apple HomeKit with Siri.

