

OVERVIEW: RB08 MKII CHAIN CONTROL S40/ S45 SYSTEM

The progression to the RB08 MKII Chain Control System is due to the implementation of several advancements made in Acmeda's development program, improving the overall performance, function and appearance of the previous design/model.

AESTHETIC FEATURES

- Smooth / clean aesthetical appearance.
- New ergonomic bracket design with square edge profile.

ASSEMBLY / INSTALLATION BENEFITS

- Easy-Lock effortless installation.
- 7mm adjustable Idler Extension.
- Improved installation with self locating grooves.

FUNCTIONAL BENEFITS

- Improved chain retention system, securing chain within mechanism during operation.

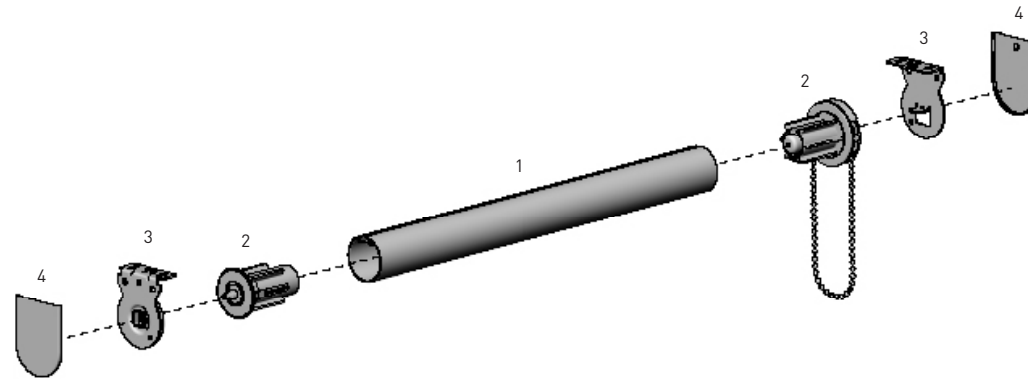

SYSTEM INDEX

| | |
|---|--|
| 1 | Aluminium Tube - S40/S45 RB91-02##-000##0 |
| 2 | Easy-Lock MKII Chain Winder & Extended Idler RB08-4002-xxx000 - S40 RB08-4502-xxx000 - S45 |
| 3 | Easy-Lock Installation Bracket RB08-8351-xxx0## - VX [40 & 55mm proj.] RB08-8314-xxx0## - AX [40 & 55mm proj.] |
| 4 | Bracket Cover Cap RB08-4151-xxx0## - VX [40 & 55mm proj.] RB08-4141-xxx0## - AX [40 & 55mm proj.] |

xxx= colour ## = size

COLOUR RANGE

| | | | | |
|-------------------|------------------|---------------|--------------------|--------------|
| | | | | |
| pure white 069 | sandstone 269 | barley 283 | silver grey 338 | black 050 |

SYSTEM OPTIONS

MOUNTING RAIL



COMBO BRACKETS



RETRO-FIT BOOSTER



FIXED GUIDE WINDER SETS

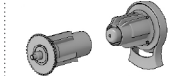

ADD ON SYSTEMS

ROUND BOX 90

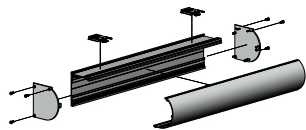

FRS100 VALANCE

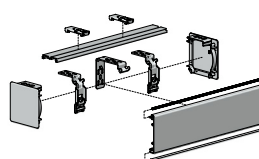

EASY-LINK S40 / S45

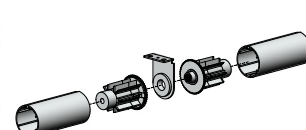

SQUARE BOX 100

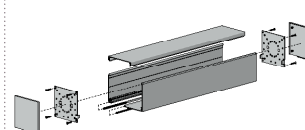

INTERNAL WIRE GUIDE



SPECIFICATIONS: RB08 MKII CHAIN CONTROL S40/ S45 SYSTEM

MAX ROLL

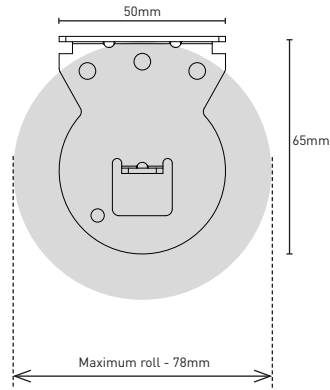

DEDUCTIONS

EXTENDED IDLE END

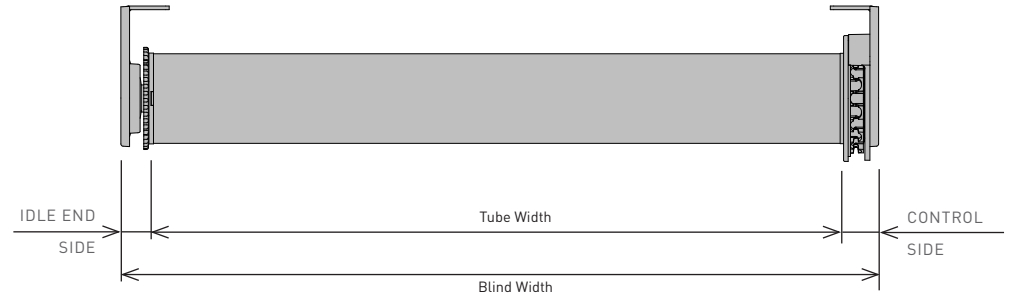
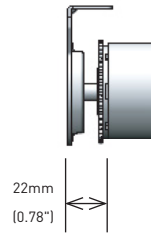

| | IDLE END SIDE | CONTROL SIDE | OVERALL DEDUCTION |
|---------------------------------|---------------|--------------|-------------------|
| VX/AX BRACKETS - with covers | 15mm [0.59"] | 17mm [0.66"] | 32mm [1.25"] |
| VX/AX BRACKETS - withOUT covers | 14mm [0.55"] | 15mm [0.59"] | 29mm [1.14"] |

ALUMINIUM TUBES

TUBE CAPACITY CHART

S40

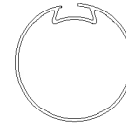
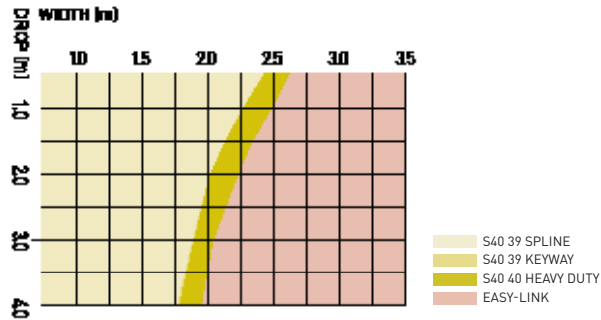

S40 | 39SPLINE
Aluminium Tube

CODE: RB91-0237-000480
with D/S tape RB91-6237-000480
O.D: 39mm
Length: 4.8 metres



S40 | 39KEYWAY
Aluminium Tube

CODE: RB91-0238-000550
with D/S tape RB91-6238-000550
O.D: 39mm
Length: 5.5 metres

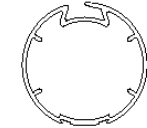

S40 | 40 HEAVY DUTY
Aluminium Tube

CODE: RB91-0240-000550
O.D: 40mm
Length: 5.5 metres

S45

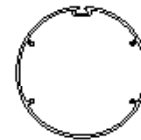
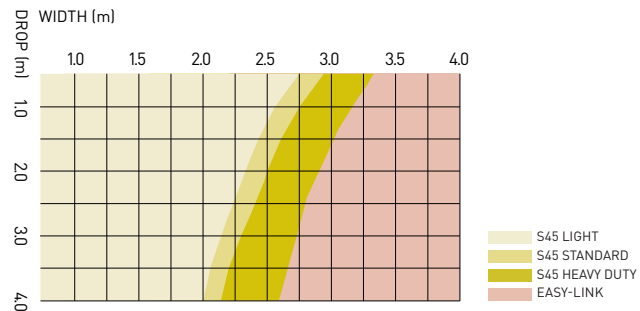

S45 LIGHT
T-Spline Tube

CODE: RB93-0443-000580
with D/S tape RB93-6443-000580
O.D: 43mm
Length: 5.8 metres

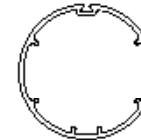

S45 STANDARD
T-Spline Tube

CODE: RB93-0444-000580
with D/S tape RB93-6444-000580
O.D: 44mm
Length: 5.8 metres

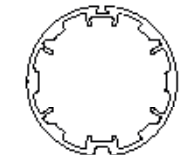

S45 HEAVY DUTY
T-Spline Tube

CODE: RB93-0449-000580
with D/S tape RB93-6449-000580
O.D: 49mm
Length: 5.8 metres