

CF CASSETTE / FASCIA SUITE | SMALL S35

Acmeda's new cassette roller suite offers a comprehensive range of head box styles, controls and side channel options with improved performance functionality and aesthetics. A contemporary round or square headbox; available in fully enclosed or partial fascia, designed to house the most commonly used medium roller systems. Utilising versatile hardware, the new cassette suite can be matched with dim-OUT side channels for improved energy efficiency.

**AESTHETICAL FEATURES**

- Clean lines and complimentary aesthetics for various applications in round or square finish.
- Both styles available as a fascia or fully enclosed cassette.
- Face and top mounting clip options available for installations with minimised light and shadow gap.
- End covers designed to overlap cassette front to hide production imperfections.
- Colour matched plastic end covers.

**PRODUCTION & ASSEMBLY FEATURES**

- Suite utilises versatile hardware for reduced inventory in creating full square or round cassettes or fascias
- 2-piece dim-OUT side guides for improved face and recess installation.
- Extrusions available in mill for custom powder coating.

**FUNCTIONAL BENEFITS**

- Compatible with most S35 Acmeda spring, chain and motorised controls.
- Co-moulded chain funnel guides for smooth and quiet operation.
- dim-OUT side channels for improved energy efficiency.

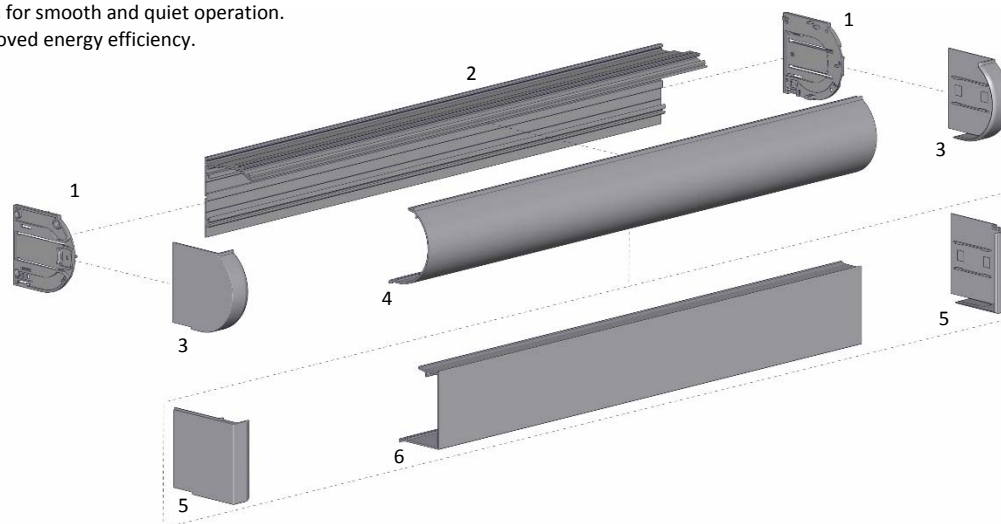

SYSTEM INDEX

1.	Cassette 75 End Plate Set RC02-0101-xxx075
2.	Cassette 75 Back RC01-0201-xxx480
3.	Cassette 75 Round Cover Set RC02-0102-xxx075
4.	Cassette 75 Round Cover RC01-0202-xxx480
5.	Cassette 75 Square Cover Set RC02-0103-xxx075
6.	Cassette 75 Square Cover RC01-0203-xxx480

xxx = colour

OPTIONS

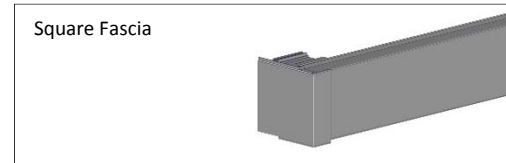
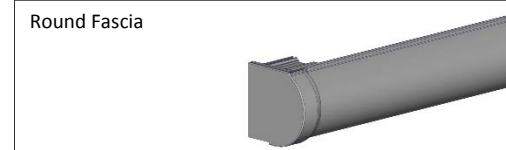

COMPATIBLE SYSTEMS

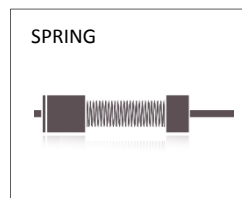
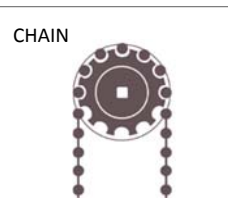

SYSTEM OPTIONS

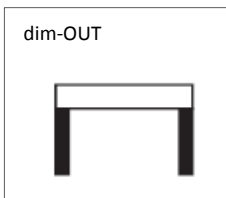

COLOUR RANGE



SPECIFICATIONS

MAX ROLL

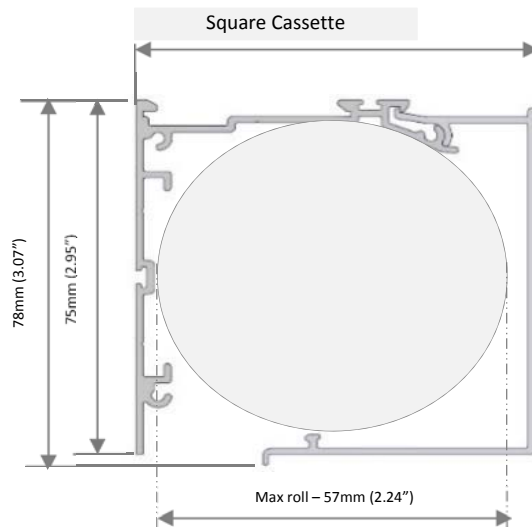
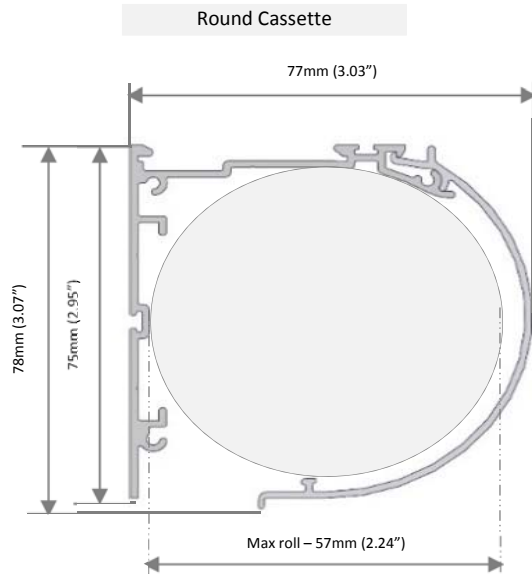

DEDUCTIONS

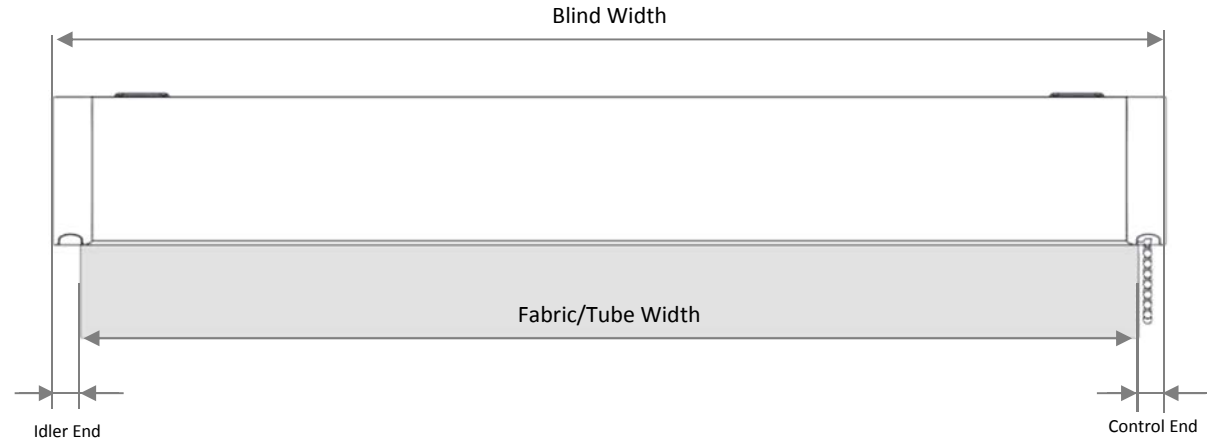

IDLER END	CONTROL END		
<b>RB08</b>	<b>RB02 SPRING</b>	<b>Li-ion 1.1 - Motor</b>	<b>RB08 CHAIN WINDER</b>
18mm 0.709"	19mm 0.748"	17mm 0.669"	20mm 0.787"