

# Cassette Systems

## Fabrication & Installation Instructions

### Cassette 80, 100, 120



## All Cassette Components

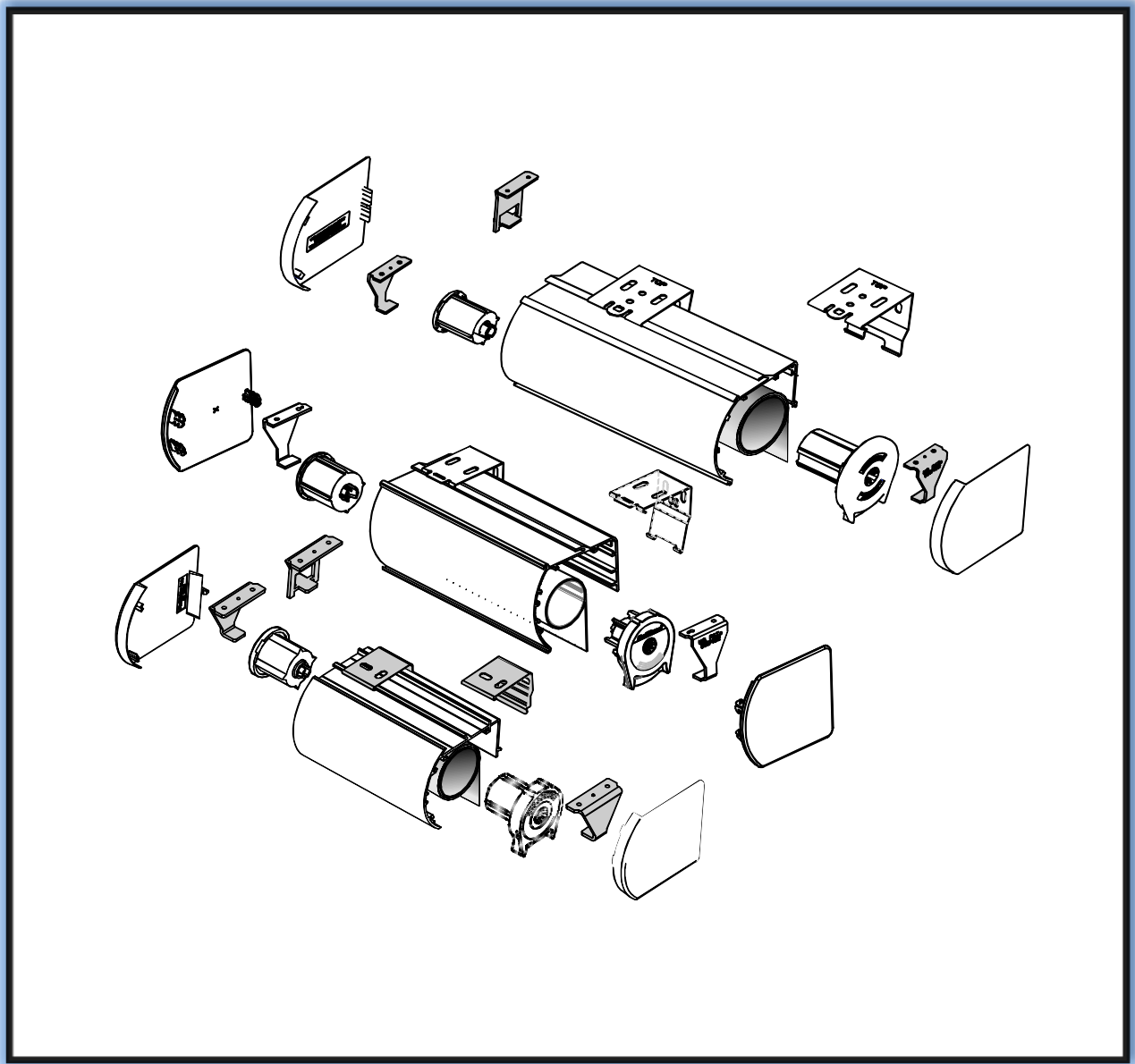

<b>Cassette Systems Tools Needed</b>	<b>page 4</b>
<b>Cassette 80</b>	<b>page 5-12</b>
<i>System Diagram-Skyline</i>	<i>page 5</i>
<i>System Diagram-R-Series</i>	<i>page 6</i>
<i>Components Needed</i>	<i>page 7</i>
<i>Fabrication Instructions</i>	<i>page 8-10</i>
<i>Installation Instructions</i>	<i>page 11-12</i>
<b>Cassette 100</b>	<b>page 13-19</b>
<i>System Diagram-Skyline</i>	<i>page 13</i>
<i>System Diagram-R-Series</i>	<i>page 14</i>
<i>Components Needed</i>	<i>page 15</i>
<i>Fabrication Instructions</i>	<i>page 16-17</i>
<i>Installation Instructions</i>	<i>page 18-19</i>
<b>Cassette 120</b>	<b>page 20-27</b>
<i>System Diagram-Skyline</i>	<i>page 20</i>
<i>System Diagram-R-Series</i>	<i>page 21</i>
<i>Components Needed</i>	<i>page 22</i>
<i>Fabrication Instructions</i>	<i>page 23-25</i>
<i>Installation Instructions</i>	<i>page 26-27</i>
<b>Inserting Zebra Fabric</b>	<b>page 28-29</b>

## All Cassette Systems Tools Needed

Cutting Table for Fabric
Saw
Screwdriver/Power Drill
Screws (screw type dependent on surface you are installing the shade)
Hammer/Mallet
Measuring Tape
Level
Ladder
Eye Protection
Gloves

### Skyline Cassette 80 System Diagram

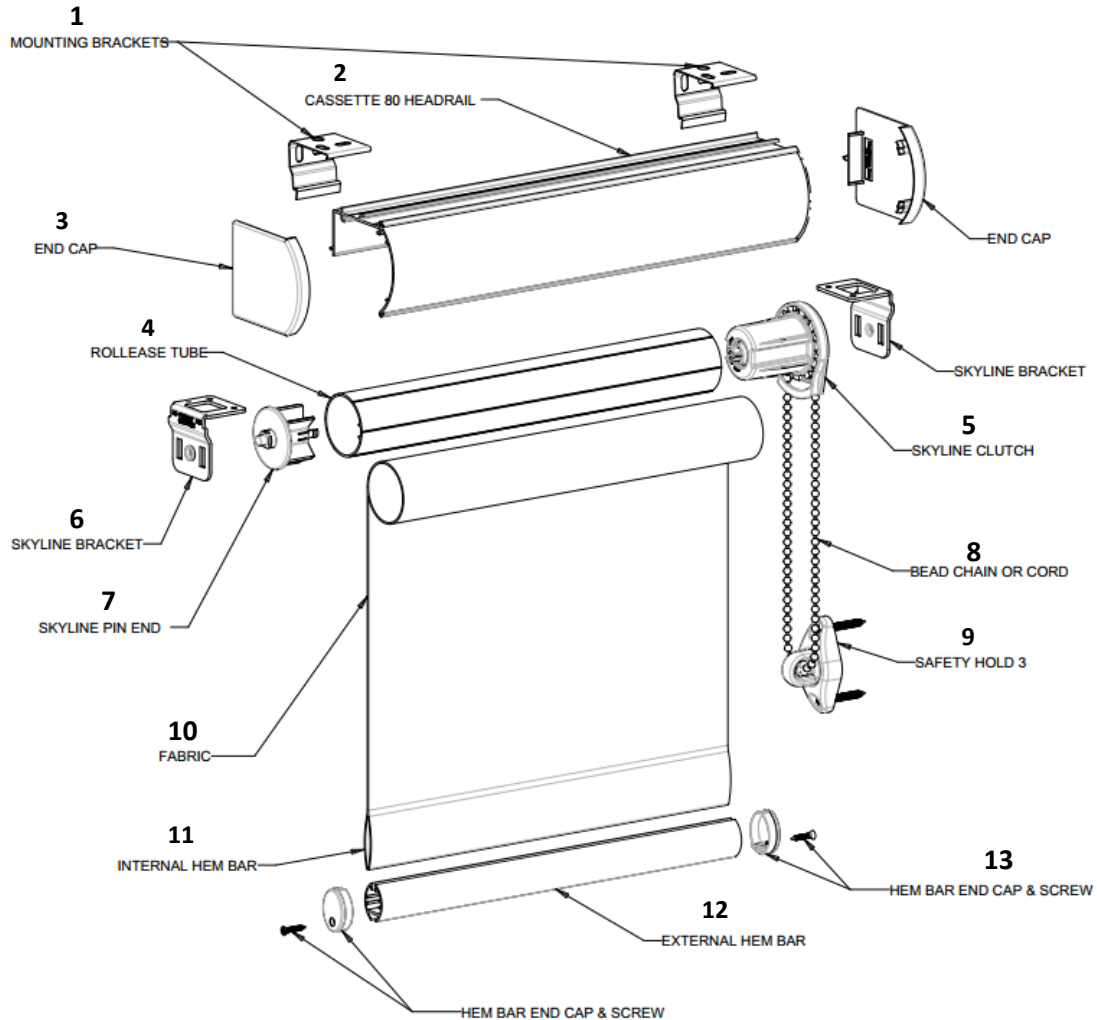

1	Mounting Brackets
2	Cassette 80 Headrail
3	End Cap
4	RollEase Tube
5	Skyline Clutch
6	Skyline Bracket
7	Skyline Pin End (Idler)
8	Bead Chain or Cord
9	SafetyHold 3
10	Fabric
11	Internal Hem Bar
12	External Hem Bar
13	Hem Bar End Cap & Screw

Maximum Roll Diameter is 1-7/8"

Cassette 80 Headrail is  
2.39" Tall x 2.94" Wide

*Note: Use either Internal OR External Hem Bar  
with End Cap & Screws*

### R-Series Cassette 80 System Diagram

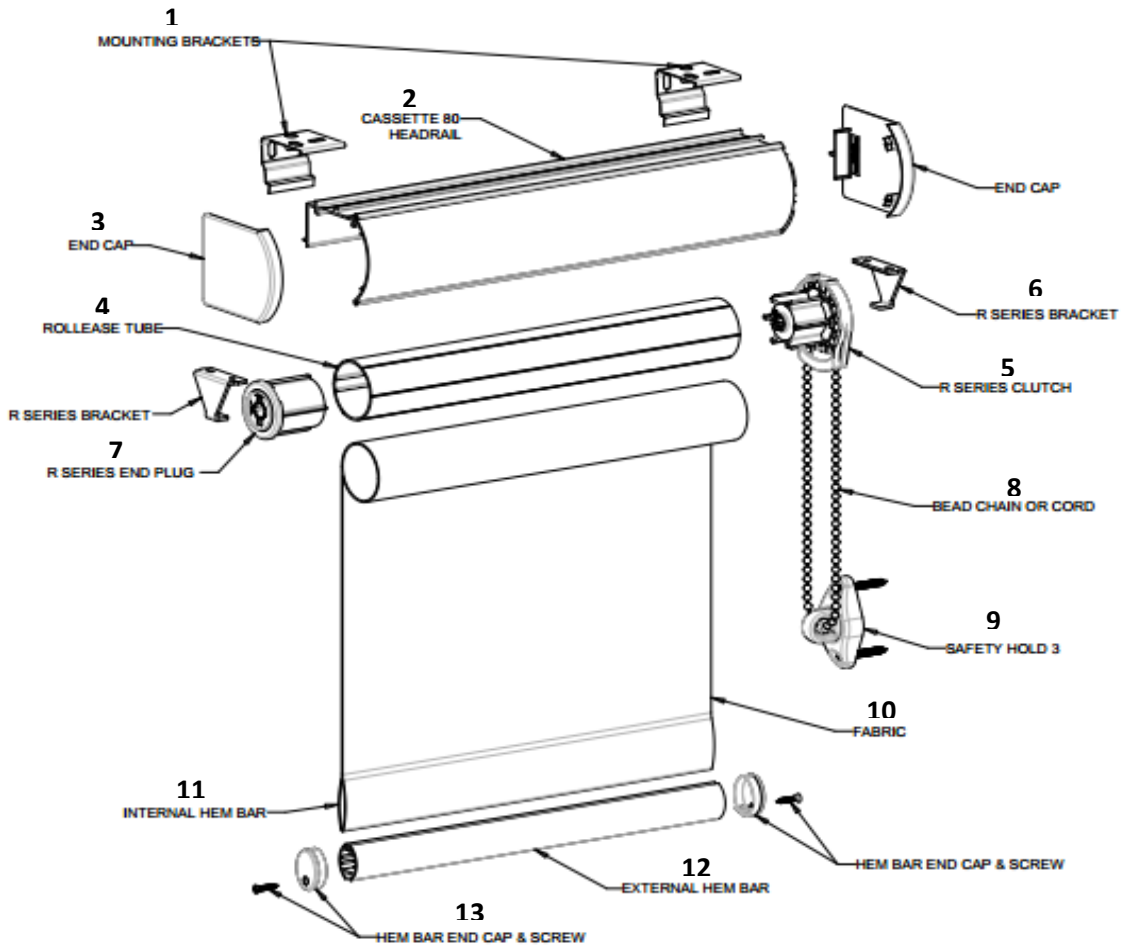







1	Mounting Brackets
2	Cassette 80 Headrail
3	End Cap
4	RollEase Tube
5	R-Series Clutch
6	R-Series Brackets
7	R-Series End Plug (Idler)
8	Bead Chain or Cord
9	Safety Hold3
10	Fabric
11	Internal Hem Bar
12	External Hem Bar
13	External Hem Bar End Caps & Screws

Maximum Roll Diameter is 1-7/8"

Cassette 80 Headrail is  
2.39" Tall x 2.94" Wide

*Note: Use either Internal OR External Hem Bar with End Cap & Screws*

### Fabrication Instructions Skyline & R-Series Cassette 80 Single & Multiple In-Line Shades Components Needed

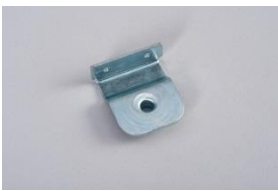
Quantity	Description	Item #	Image
1	Roller shade assembled to tube with clutch and idler inserted.	N/A	
1	Cassette 80 Headrail	CRVXX	
2	Cassette 80 End Caps	CRECXX	
Skyline- 2 brackets or R-Series- 1 set	Cassette Brackets Choose R-Series or Skyline	CRUBKT – R-Series CRUSLB - Skyline	<div style="display: flex; justify-content: space-around;"> <div style="text-align: center;"> <p>R-Series</p>  </div> <div style="text-align: center;"> <p>Skyline</p>  </div> </div>
Varies by Shade Width (1 bracket every 18")	Cassette 80 Mounting Brackets	VRBKT15	
One per linked shade	Intermediate Brackets For use when using multiple in-line manual shades together with multiple clutches	CRIMBKT – R-Series CRUSLBI - Skyline	<div style="display: flex; justify-content: space-around;"> <div style="text-align: center;"> <p>R-Series</p>  </div> <div style="text-align: center;"> <p>Skyline</p>  </div> </div>

### Skyline & R-Series 80 Cassette Fabrication

**Step 1: Cut (use RollEase deduction charts to calculate width of cuts)**

1a. Cut Headrail

1b. Cut Tube

1c. Cut Hem Bar

1d. Cut Fabric for shade and for Cassette Insert (Cassette insert should be cut 2-1/2"-2-9/16" wide, and as long as the total length of the headrail)

**Step 2: Assemble Shade per usual assembly method**

2a. Attach Hem Bar to Fabric

2b. Attach Fabric to taped tube

2c. Attach Bead Chain or Cord to Clutch

2d. Attach Tension Device to Cord or Bead Chain (see Safety Hold3 Instructions)

**Step 3: Insert Fabric Strip into Cassette Headrail**

3a. Apply two sided tape to headrail

3b. Insert fabric into groove in headrail, beginning on either side rolling fabric over the headrail and slipping into the groove on the opposite side.



**Step 4: Insert Clutch and Idler**

4a. Insert Clutch

4b. Insert Idler

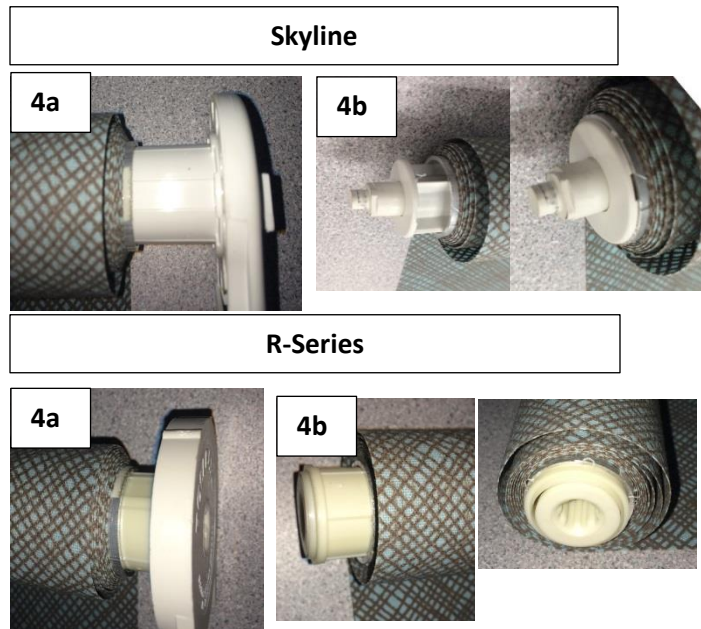



### Skyline & R-Series Cassette 80 Fabrication

#### Step 5: Assemble Headrail and assembled shade

**5a. Lay Cassette on table or flat surface. Insert one bracket by aligning bracket into grooves on inside top of the headrail. Push bracket all the way in. (be careful not to bend bracket if using a mallet or hammer to tap brackets in) If desired, use screws to hold brackets in place**

**5b. Insert clutch and idler end of tube onto the bracket. (see note for R-Series)**

**5c. Attach End Caps (if desired)**

5a.

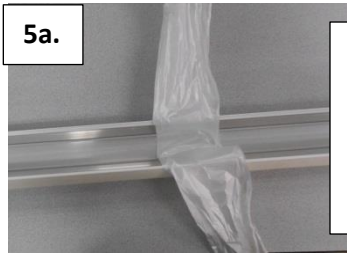

Lay plastic across cassette before laying in tube with fabric. After installing shade, tie around the top of cassette to prevent shade from falling during shipment to customer.

#### Skyline

5a.



Gently tap bracket into headrail

For Skyline, insert idler side first. Push into bracket, and slip clutch side down until the hooks engage in the holes in the bracket and lock into place.

5b.



Push tip of pin end into hole in the center of the Skyline bracket

Engage the hooks of the Skyline clutch into the slots in the bracket and secure in place

5b.



#### R-Series

5a.



When fabricating R-Series, you must insert one bracket and insert clutch or pin end, and then simultaneously insert other bracket into the opposite end.

5b.

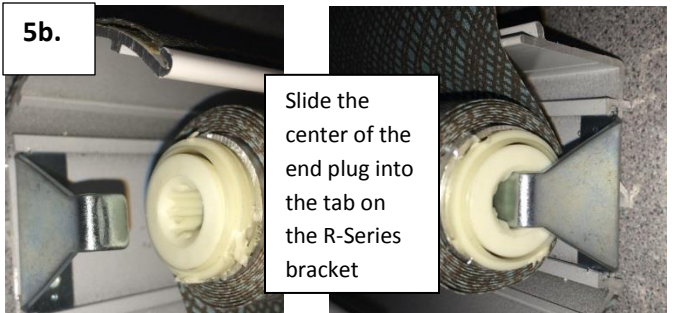

Slide the center of the end plug into the tab on the R-Series bracket

Slide the hole in the center of the clutch into the tab on the R-Series Bracket

5b.

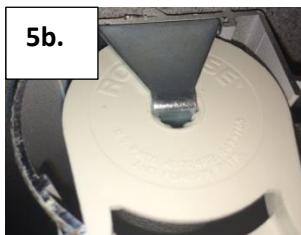

### Skyline & R-Series Cassette 80 Fabrication

Attach End Caps

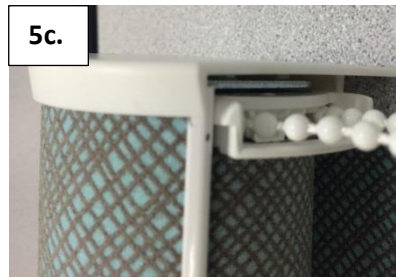

#### Step 6: Pack and Ship

**6a. Wrap Cassette in correct packaging material and box. Include Mounting Brackets and Screws**

**6b. Your Cassette is now ready to ship.**

*Note: Be sure that Safety Tags are attached and the shade is inoperable and compliant with the WCMA Standards.*

### Skyline & R-Series – Inside & Outside Mount Cassette 80 Installation

**Step 1: Carefully remove shade from the box and package wrapping.**

TIP: Installation is the same in both Skyline and R-Series applications. However, deduction data will vary.

**Step 2: Install Mounting Brackets using correct screws.**

**Tip: Mounting Brackets should be placed approximately every 18"**

Inside Mount

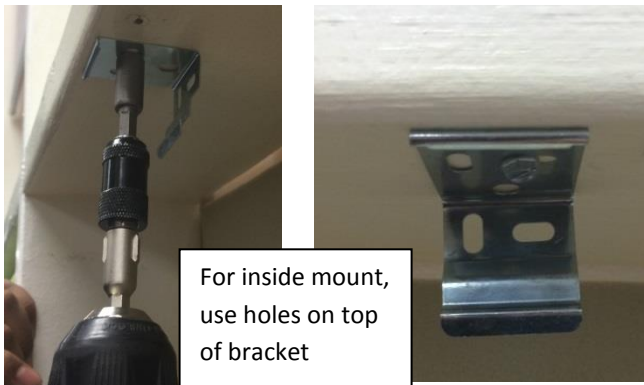

For inside mount,  
use holes on top  
of bracket

Outside Mount



For outside mount,  
use holes on the back  
of bracket

**Step 3: Install Headrail**

**Snap Headrail into place by sliding groove in back of headrail into the bottom of the mounting bracket. Push forward and up, snapping the headrail into the top of the mounting bracket.**

Inside Mount



Outside Mount

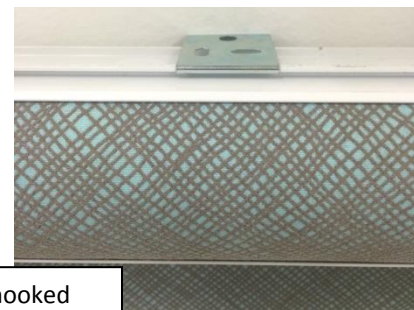

Be sure the hooked  
part of the bracket is  
fully engaged around  
the headrail

**Skyline & R-Series – Inside & Outside Mount  
Cassette 80 Installation**

**Step 4: Install Tension Device (See instructions for Safety Hold3)**

**Installed Shade: Inside Mount**



**Installed Shade: Outside Mount**



### Skyline Cassette 100 System Diagram

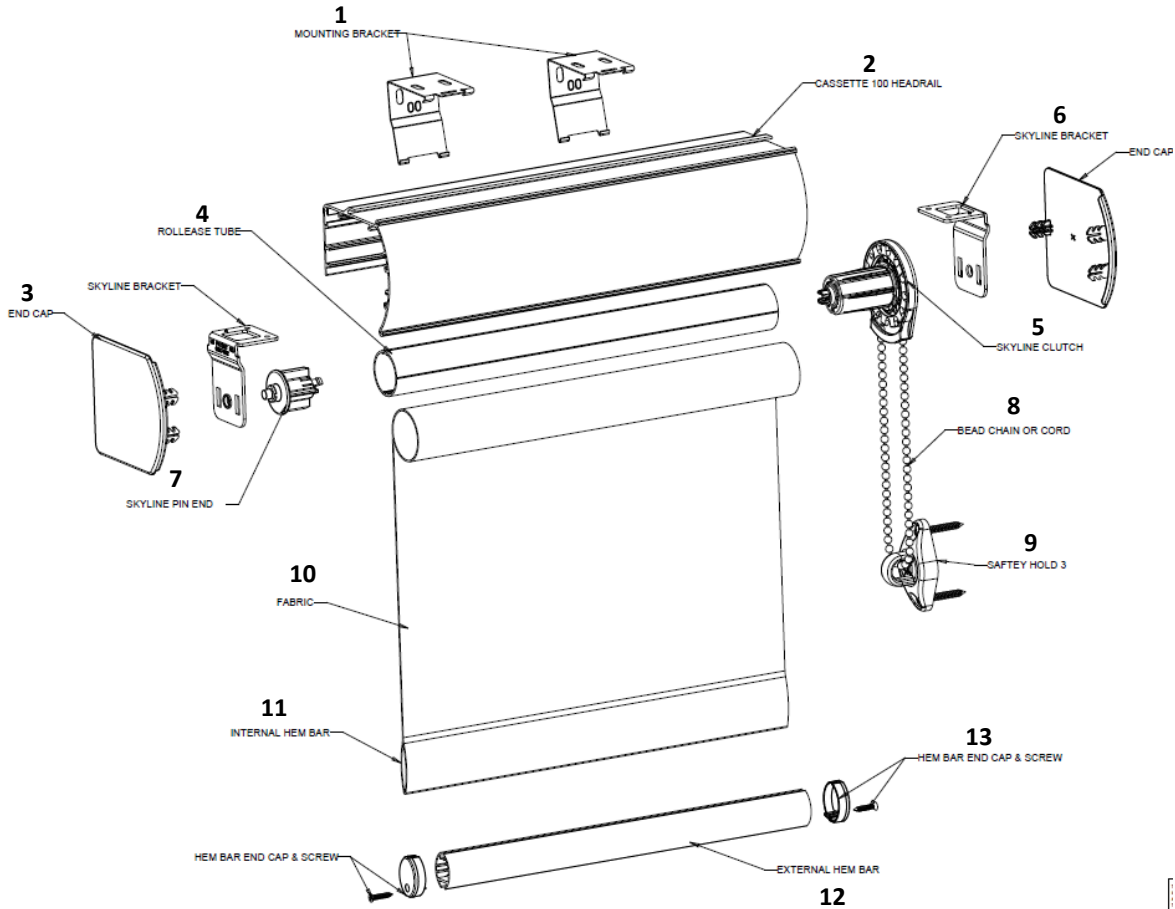

1	Mounting Brackets
2	Cassette 100 Headrail
3	End Cap
4	RollEase Tube
5	Skyline Clutch
6	Skyline Bracket
7	Skyline Pin End (Idler)
8	Bead Chain or Cord
9	SafetyHold 3
10	Fabric
11	Internal Hem Bar
12	External Hem Bar
13	Hem Bar End Cap & Screw

Maximum Roll Diameter is 2-1/2"

Cassette 100 Headrail is  
3.10" Tall x 3.72" Wide

*Note: Use either Internal OR External Hem Bar with End Cap & Screws*

### R-Series Cassette 100 System Diagram

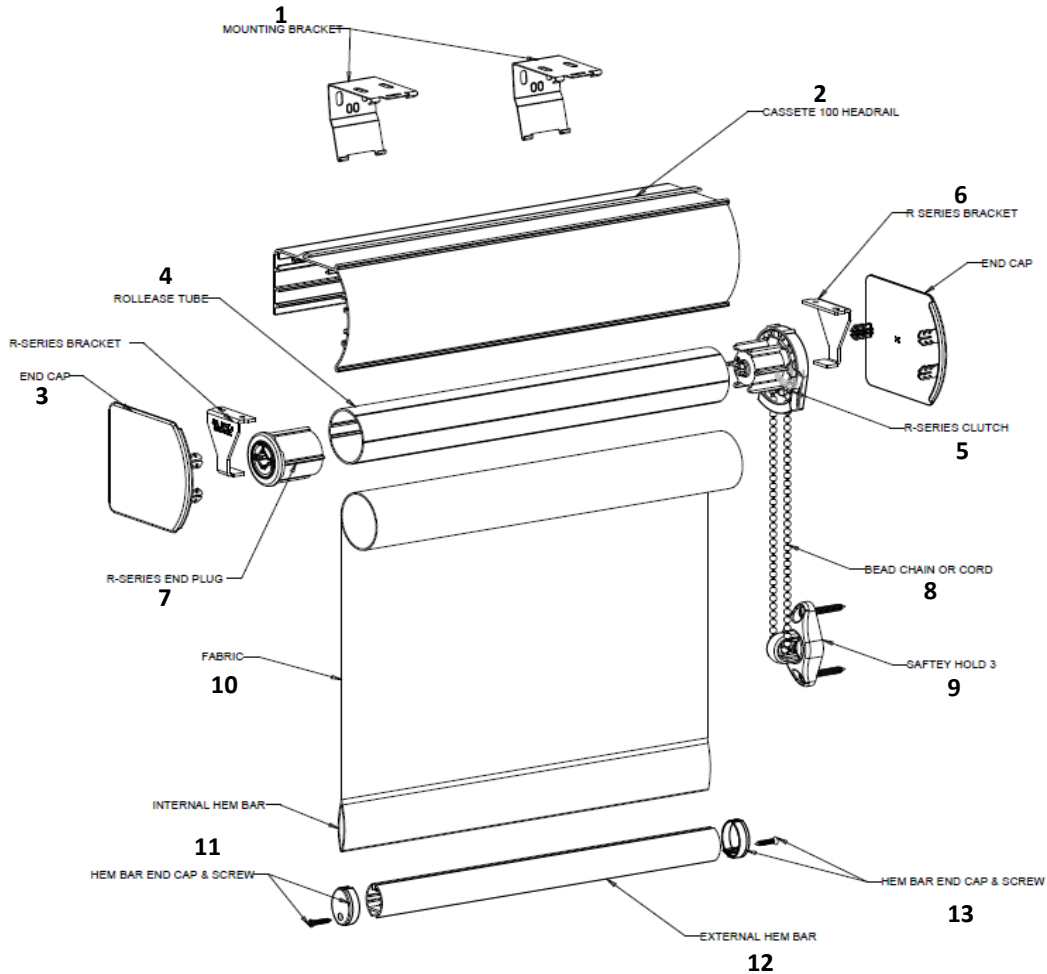







1	Mounting Brackets
2	Cassette 100 Headrail
3	End Cap
4	RollEase Tube
5	R-Series Clutch
6	R-Series Bracket
7	R-Series End Plug (Idler)
8	Bead Chain or Cord
9	SafetyHold 3
10	Fabric
11	Internal Hem Bar
12	External Hem Bar
13	External Hem Bar End Caps & Screws

Maximum Roll Diameter is 2-1/2"

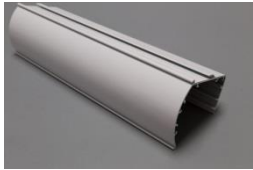
Cassette 100 Headrail is  
3.10" Tall x 3.72" Wide

*Note: Use either Internal OR External Hem Bar with End Cap & Screws*

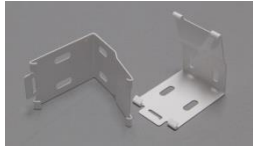
### Fabrication Instructions Skyline & R-Series Cassette 100 Components Needed

Quantity	Description	Item #	Image
1	Roller shade assembled to tube with clutch and idler inserted.	N/A	
1	Cassette 100 Headrail	CRV100XX	
2	Cassette 100 End Caps	CREC100XX	
Choose 2 - Skyline brackets or 1 set - R-Series Brackets	Cassette Brackets Choose R-Series or Skyline	CRUBKT53 – R-Series CRUSLB - Skyline	<div style="display: flex; justify-content: space-around;"> <div style="text-align: center;"> <p>R-Series</p>  </div> <div style="text-align: center;"> <p>Skyline</p>  </div> </div>
Varies by Shade Width (1 bracket every 18")	Cassette 100 Mounting Brackets	HDBKTXX	
Varies by Shade Width (1 bracket every 18")	Intermediate Brackets For use when using multiple in-line manual shades together with multiple clutches	CRIMBKT53 – R-Series CRUSLB660I or CRUSLB680I - Skyline	<div style="display: flex; justify-content: space-around;"> <div style="text-align: center;"> <p>R-Series</p>  </div> <div style="text-align: center;"> <p>Skyline</p>  </div> </div>

## Cassette 100

### Skyline & R-Series 100 Cassette Fabrication

#### Step 1: Cut (use RollEase deduction charts to calculate width of cuts)

- 1a. Cut Headrail
- 1b. Cut Tube
- 1c. Cut Hem Bar
- 1d. Cut Fabric for shade and for Cassette Insert (Cassette insert should be cut 3"-3-1/8" wide, and as long as the total length of the headrail)

#### Step 2: Assemble Shade

- 2a. Attach Hem Bar to Fabric
- 2b. Attach Fabric to taped tube
- 2c. Attach Bead Chain or Cord to Clutch
- 2d. Attach Tension Device to Cord or Bead Chain (see Safety Hold3 Instructions)

#### Step 3: Insert Fabric Strip into Cassette Headrail

- 3a. Apply two sided tape to headrail
- 3b. Insert fabric into groove in headrail, beginning on either side rolling fabric over the headrail and slipping into the groove on the opposite side.

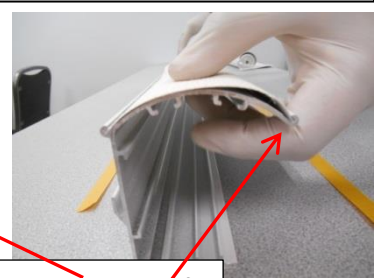
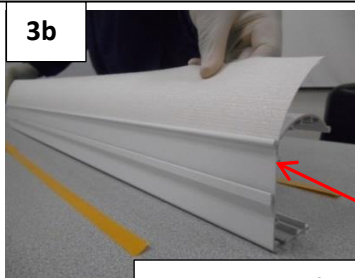

Slowly tuck in fabric starting at one side of the cassette and moving to the other

#### Step 4: Insert Clutch and Idler

- 4a. Insert Clutch
- 4b. Insert Idler

#### Skyline



#### R-Series





### Skyline & R-Series Cassette 100 Fabrication

#### Step 5: Assemble Headrail and assembled shade

- 5a. Lay Cassette on table or flat surface. Insert one bracket by aligning bracket into grooves on inside top of the headrail. Push bracket all the way in. (be careful not to bend bracket if using a mallet or hammer to tap brackets in) If desired, use screws to hold brackets in place
- 5b. Insert clutch and idler end of tube onto the bracket. (see note for R-Series)
- 5c. Attach End Caps (if desired)

5a.

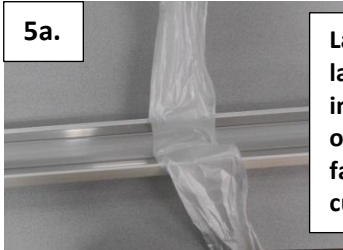

Lay plastic across cassette before laying in tube with fabric. After installing shade, tie around the top of cassette to prevent shade from falling during shipment to customer.

#### Skyline

5a.



Gently tap bracket into headrail

5b.

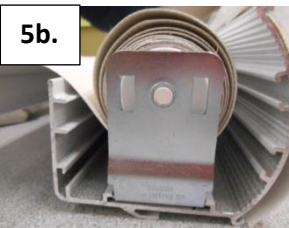

Push tip of pin end into hole in the center of the Skyline bracket.

5b.

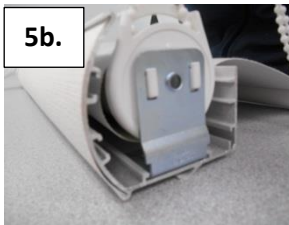

For Skyline, insert idler side first. Push into bracket, and slip clutch side down until the hooks engage in the holes in the bracket and lock into place.

Engage the hooks of the Skyline clutch into the slots in the bracket and secure in place.

#### R-Series

5b.

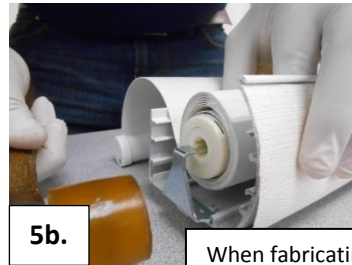

When fabricating R-Series, you must insert one bracket and insert clutch or pin end, and then simultaneously insert other bracket into the opposite end.

5c.

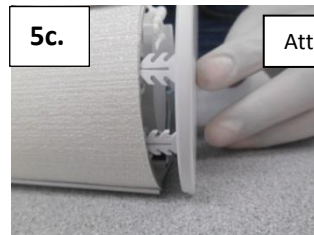

Attach End Caps



#### Step 6: Pack and Ship

- 6a. Wrap Cassette in correct packaging material and box. Include Mounting Brackets and Screws
- 6b. Your Cassette is now ready to ship.

*Note: Be sure that Safety Tags are attached and the shade is inoperable and compliant with the WCMA Standards.*

### Skyline & R-Series – Inside Mount & Outside Mount Cassette 100 Installation

**Step 1: Carefully remove shade from the box and package wrapping.**

TIP: Installation is the same in both Skyline and R-Series applications. However, deduction data will vary.

**Step 2: Install Mounting Brackets using correct screws.**

**Tip: Mounting Brackets should be placed approximately every 18"**

**Inside Mount**



For inside mount,  
use holes on top  
of bracket

**Outside Mount**



For outside mount,  
use holes on the back  
of bracket

**Step 3: Install Headrail**

**Snap Headrail into place by sliding groove in back of headrail into the bottom of the mounting bracket. Push forward and up, snapping the headrail into the top of the mounting bracket.**



Be sure the hooked  
part of the bracket is  
fully engaged around  
the headrail

**Skyline & R-Series– Inside & Outside Mount  
Cassette 100 Installation**

**Step 4: Install Tension Device (See instructions for Safety Hold3)**

**Installed Shade: Inside Mount**



**Installed Shade: Outside Mount**



### Skyline Cassette 120 System Diagram

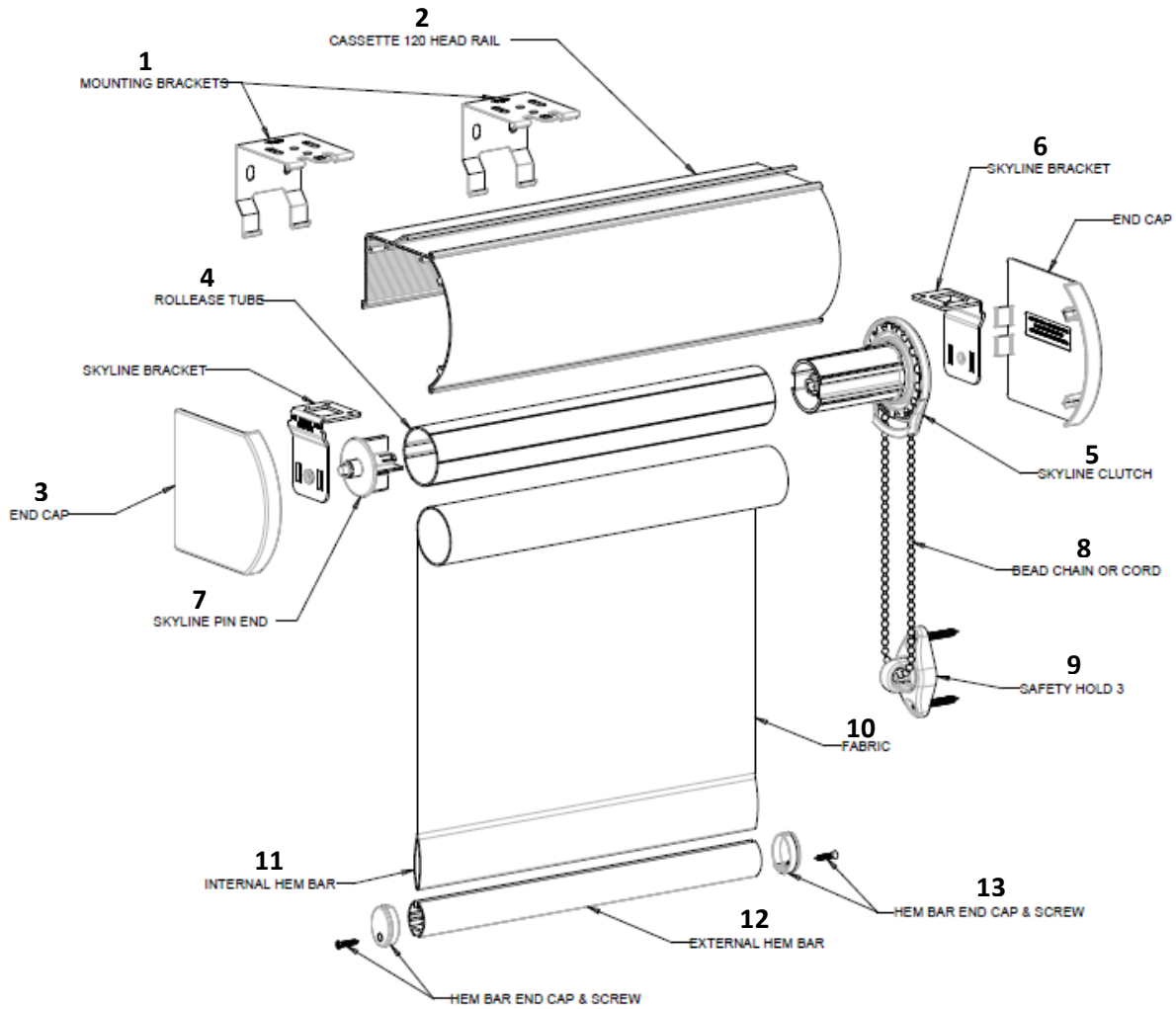

1	Mounting Brackets
2	Cassette 120 Headrail
3	End Cap
4	RollEase Tube
5	Skyline Clutch
6	Skyline Bracket
7	Skyline Pin End (Idler)
8	Bead Chain or Cord
9	SafetyHold 3
10	Fabric
11	Internal Hem Bar
12	External Hem Bar
13	Hem Bar End Cap & Screw

Maximum Roll Diameter is 2-7/8"

Cassette 120 Headrail is  
3.88" Tall x 4.43" Wide

Note: Use either Internal OR External Hem Bar with End Cap & Screws

### R-Series Cassette 120 System Diagram

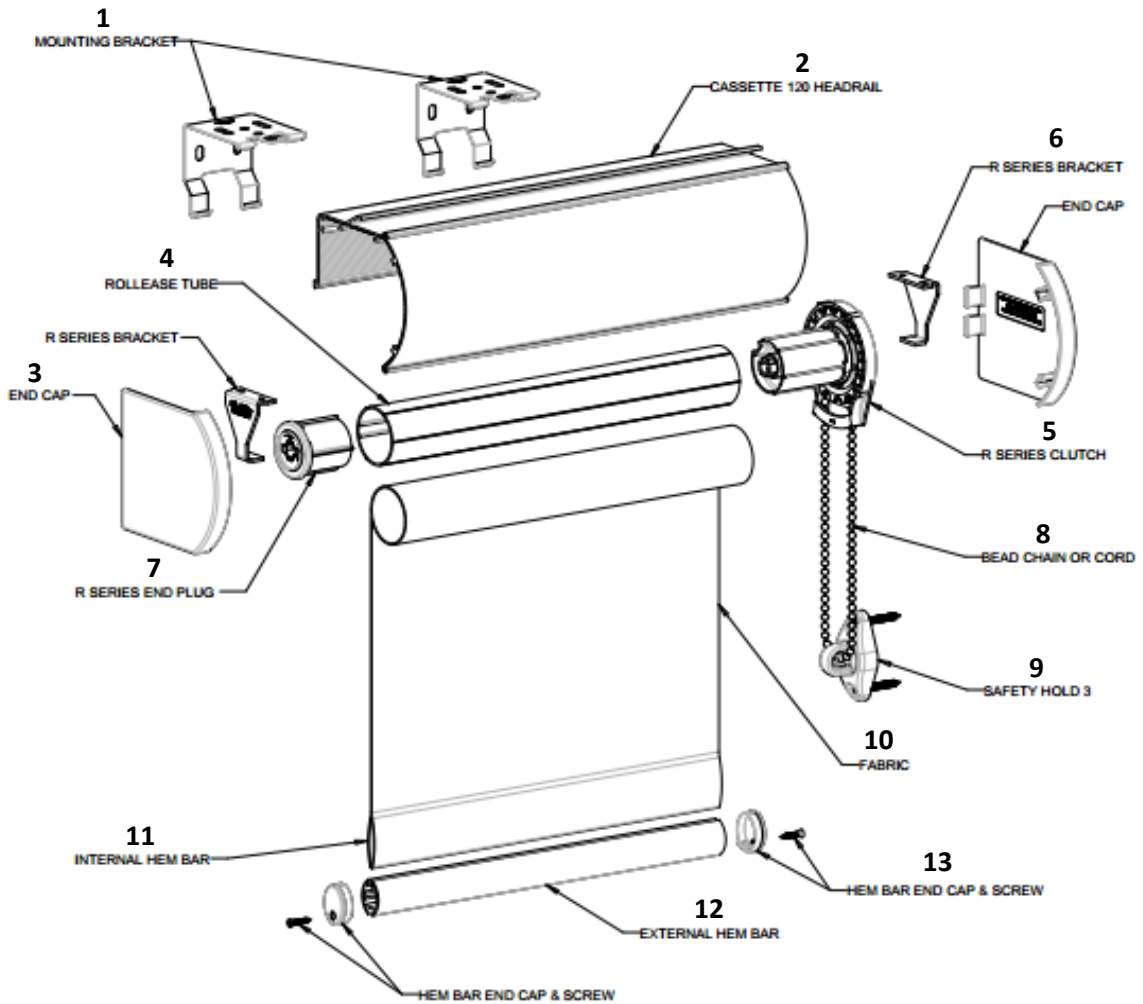

1	Mounting Brackets
2	Cassette 120 Headrail
3	End Cap
4	RollEase Tube
5	R-Series Clutch
6	R-Series Bracket
7	R-Series End Plug (Idler)
8	Bead Chain or Cord
9	SafetyHold 3
10	Fabric
11	Internal Hem Bar
12	External Hem Bar
13	Hem Bar End Cap & Screw

Maximum Roll Diameter is 2-7/8"

Cassette 120 Headrail is  
3.88" Tall x 4.43" Wide

*Note: Use either Internal OR External Hem Bar with End Cap & Screws*

## Cassette 120

Quantity	Description	Item #	Image
1	Roller shade assembled to tube with clutch and idler inserted.	N/A	
1	Cassette 120 Headrail	CRV53XX	
2	Cassette 120 End Caps	CREC53XX	
Choose 2 - Skyline brackets or 1 set - R-Series Brackets	Cassette Brackets Choose R-Series or Skyline	CRUBKT53 – R-Series CRUSLB - Skyline	<div style="display: flex; justify-content: space-around;"> <span>R-Series</span> <span>Skyline</span> </div> 
Varies by Shade Width (1 bracket every 18")	Cassette 120 Mounting Brackets	V2BKTXX	
Varies by Shade Width (1 bracket every 18")	Intermediate Brackets For use when using multiple in-line manual shades together with multiple clutches	CRIMBKT53 – R-Series CRUSLB660I or CRUSLB680I - Skyline	<div style="display: flex; justify-content: space-around;"> <span>R-Series</span> <span>Skyline</span> </div> 

### Skyline & R-Series Cassette 120 Fabrication

**Step 1: Cut (use RollEase deduction charts to calculate width of cuts)**  
 1a. Cut Headrail  
 1b. Cut Tube  
 1c. Cut Hem Bar  
 1d. Cut Fabric for shade and for Cassette insert

**Step 2: Assemble Shade**  
 2a. Attach Hem Bar to Fabric  
 2b. Attach Fabric to tube  
 2c. Attach Bead Chain or Cord to Clutch  
 2d. Attach Tension Device to Cord or Bead Chain (See SH3 Instructions)

**Step 3: Insert Fabric Strip into Cassette Headrail (Cassette insert should be cut 4"-4-1/16" wide, and as long as the total length of the headrail)**

3a. Apply two sided tape to headrail  
 3b. Insert fabric into groove in headrail, beginning on either side rolling fabric over the headrail and slipping into the groove on the opposite side.

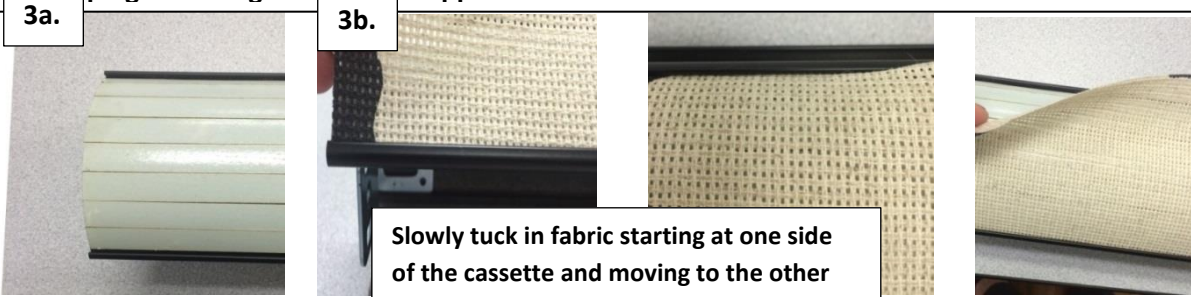

**Step 4: Insert Clutch and Idler**

4a. Insert Clutch

4b. Insert Idler

Skyline

R-Series

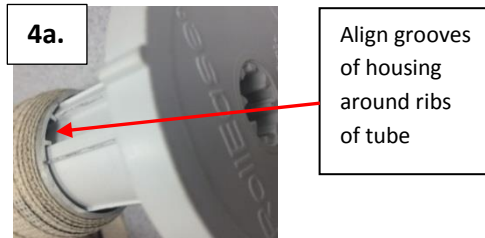

### Skyline & R-Series Cassette 120 Fabrication

#### Step 5: Assemble Headrail and Tube

**5a. Lay Cassette on table or flat surface. Insert one bracket by aligning bracket into grooves on top of the headrail. Push bracket all the way in. (be careful not to bend bracket if using a mallet or hammer to tap brackets in) If desired, use screws to hold brackets in place**

**5b. Insert clutch or idler end of tube onto the bracket. (see note for R-Series)**

**5c. Attach End Caps (if desired)**

5a.



Lay plastic across cassette before laying in tube with fabric. After installing shade, tie around the top of cassette to prevent shade from falling during shipment to customer.

#### Skyline

#### R-Series

5a.



Gently tap bracket into the grooves in the headrail



For Skyline, insert idler side first. Push into bracket, and slip clutch side down until the hooks engage in the holes in the bracket and lock into place.

5b.

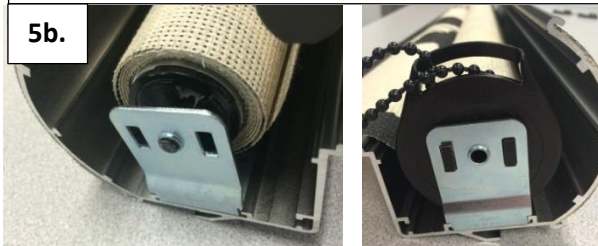

When fabricating R-Series, you must insert one bracket and insert clutch or pin end, and then simultaneously insert other bracket into the opposite end.

5b.

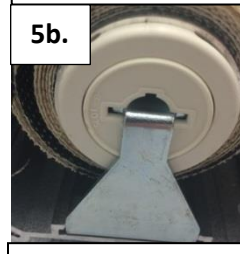

Slide End Plug into the tab of bracket



Slide hole in the middle of the R-Series Clutch into the tab of bracket



## Cassette 120

### Skyline & R-Series Cassette 120 Fabrication

Slide tabs on end cap  
into cassette



#### **Step 6: Pack and Ship**

**6a. Wrap Cassette in correct packaging material and box. Include Mounting Brackets and Screws.**

**6b. Your Cassette is now ready to ship.**

***Note: Be sure that Safety Tags are attached and the shade is inoperable and compliant with the WCMA Standards.***

### Skyline & R-Series – Inside & Outside Mount Cassette 120 Installation

**Step 1: Carefully remove shade from the box and package wrapping.**

TIP: Installation is the same in both Skyline and R-Series applications. However, deduction data will vary.

**Step 2: Install Mounting Brackets using correct screws.**

**2a. Mounting Brackets should be placed approximately every 18"**

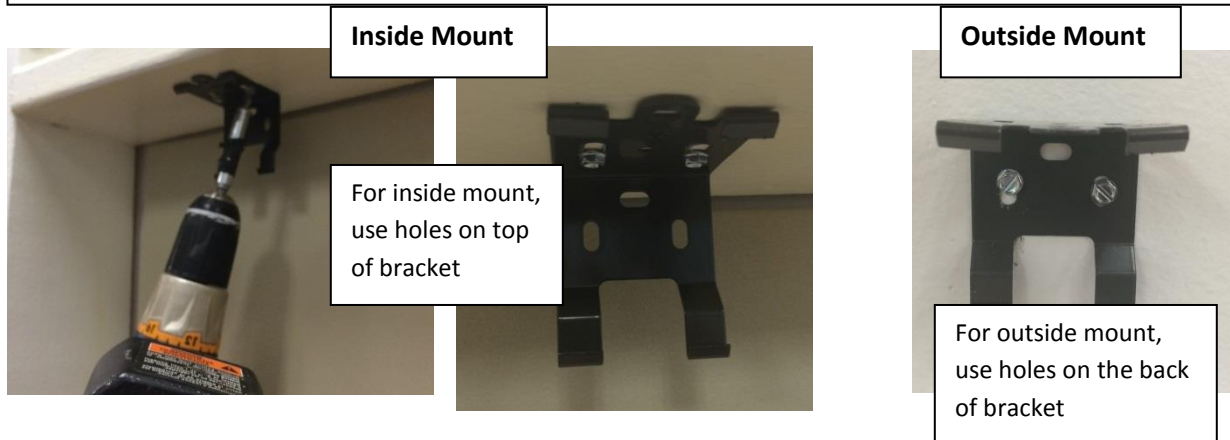

**Step 3: Install Headrail**

**3a. Snap Headrail into place by sliding groove in headrail into the mounting bracket and snapping upwards to lock headrail in place**

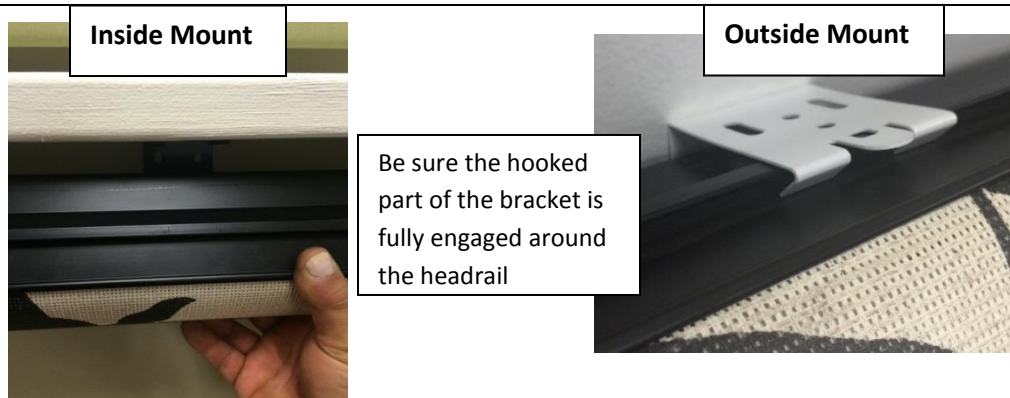

**Step 4: Install Tension Device**

**4a. See instructions for Safety Hold3**

**Skyline & R-Series – Inside & Outside Mount  
Cassette 120 Installation**

**Installed Shade  
Inside Mount**



**Installed Shade  
Outside Mount**



## Skyline & R-Series – Zebra Fabric Installation Cassette 100 & 120

**Step 1: Lay zebra fabric out on table**

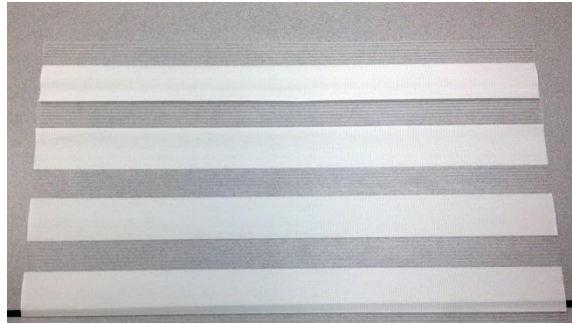

**Step 2a: Cut hembar tape to the same width as the fabric.  
Step 2b: Stick edge of hembar tape to the edge of the fabric.**

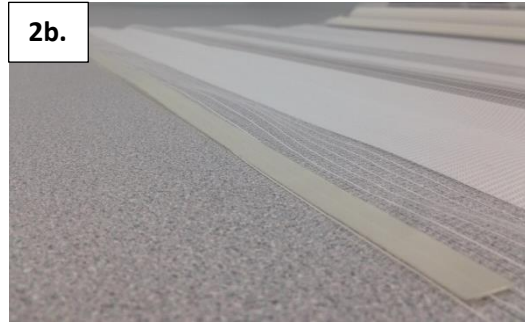
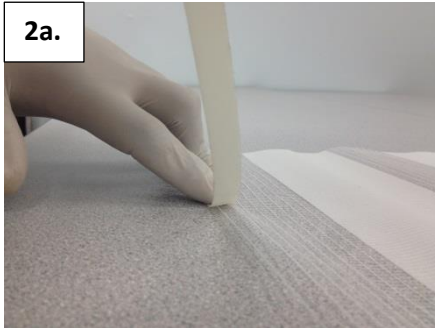

**Step 3a: Fold the taped edge twice to help add support to the tape.  
Step 3b: Staple folded edge to keep the fabric from coming unfolded.**

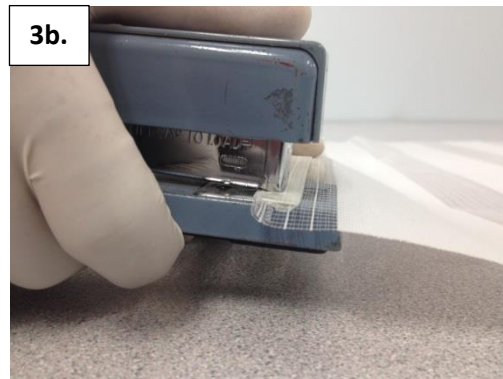
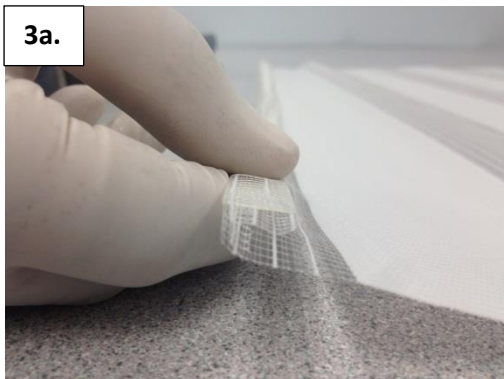

## Skyline & R-Series – Zebra Fabric Installation Cassette 100 & 120

**Step 4: Slide rolled fabric edge through top ridges on the inside-back of cassette headrail.**

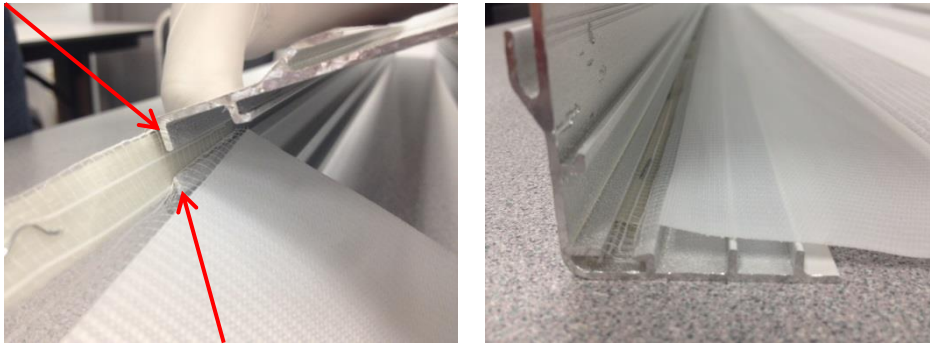

**Installed Zebra  
Fabric**



*Cassette 100 Shown*